

Delivering leading edge, innovative power solutions for more than **30** years....

Model:GT-46181-18VV-T3A

September 19, 2019

DOE EPS 2.0 Level VI 60950 Class II Rated Desktop/Tabletop Power Supply / Charger / AC Adapter, 18W, Available with 5-24VDC output.

Information

Model Number GT-46181-18VV-T3A

Description GT-46181-18VV-T3A, ITE Power Supply, Desktop/External, Regulated Switchmode AC-DC Power Supply AC Adaptor, , Input Rating: 100-240V~, 50-60 Hz, IEC 60320/C6 AC Inlet Connector, Class I, Earth Ground (aka "Mickey Mouse"), Output Rating: 18 Watts, Power rating with convection cooling (W) , 7.1-15V in 0.1V increments, Approvals: IP40; EAC; CCC; CB 60950; RCM; Level VI; CAN ICES-3; Class I; CE; China RoHS; S-Mark 60950; LPS; PSE; RoHS; Ukraine; PSE; PSE; VCCI; cULus; FCC; 230V CoC Tier 2; WEEE;

Model Picture



Agency Documents <http://www.globtek.info/certs/GT-46181-18VV-TZ/>
CE https://www.globtek.com/pdf/ec_declaration/a0Oa000000Nrw1JEAR
EC-Declaration https://www.globtek.com/pdf/rohs_cert/a0Oa000000Nrw1JEAR
RoHS/RoHS2 Declaration https://www.globtek.com/pdf/iso_certificates/REACH.pdf
REACH Declaration <https://www.globtek.com/pdf/conflict-minerals.pdf>
Conflict Minerals Declaration

Delivering leading edge, innovative power solutions for more than **30** years....

Model:GT-46181-18VV-T3A

September 19, 2019

Model Parameters

Type	Desktop/External
Technology	Regulated Switchmode AC-DC Power Supply AC Adaptor
Category	ITE Power Supply
Input Voltage	100-240V~, 50-60 Hz
I/P Amps (A)	0.5A
Wattage (W)	18.0
Vout Range (V)	7.1-15
Efficiency Level	VI
Ingress Protection	
Size (mm)	50*81*31

Delivering leading edge, innovative power solutions for more than **30** years....

Model:GT-46181-18VV-T3A

September 19, 2019

ENCLOSURE

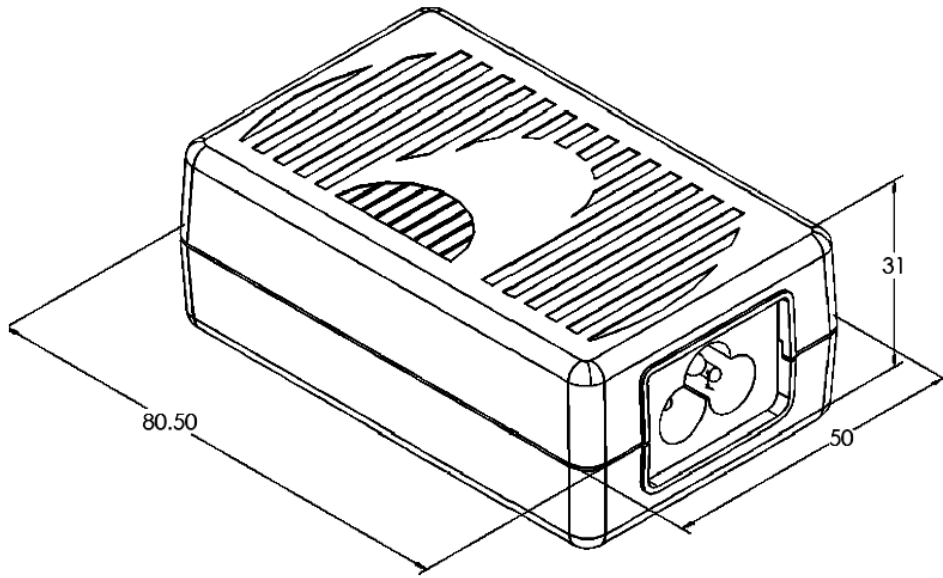

Delivering leading edge, innovative power solutions for more than **30** years....

Model:GT-46181-18VV-T3A

September 19, 2019

RATING TABLE

Model Number	Voltage	Amps(A)	Watts(W)	RFQ
GT-46181-1807-T3A	7 V	2.57	17.99	RFQ
GT-46181-1809-T3A	9 V	2	18.00	RFQ
GT-46181-1809-T3	9 V	2	18.00	RFQ
GT-46181-1812-2.5-T3A	9.5 V	1.89	17.96	RFQ
GT-46181-1812-T3A	12 V	1.5	18.00	RFQ
GT-46181-1815-1.5-T3A	13.5 V	1.333	18.00	RFQ
GT-46181-1815-T3A	15 V	1.2	18.00	RFQ

SPECIFICATIONS**A) ELECTRICAL SPECIFICATIONS:**

01. Input Voltage: Specified 90-264 Vac, Nameplate rated: 100-240Vac
02. Input Frequency: Specified 47-63 Hz, Nameplate rated 50-60Hz
03. Output Regulation: +/- 5% measured at the output connector
Output Regulation +/- 2% is optional (RFP3851)
04. Line Voltage Regulation: +/- 1% typical measured at the output connector
05. Output Ripple (Vp-p): +/-1% or 150 mV whichever is greater, measured at 20 MHz bandwidth with 0.1 uf ceramic capacitor in parallel with 10 uf electrolytic capacitor connected at the end of the output connector at nominal line
06. Turn-ON/OFF Overshoot: 5% maximum, 1 mS typical recovery time for 25% to 50% step load
07. Turn-ON Delay: 1 Second, Typical
08. Hold-Up Time: 8 mS typical @ nominal input voltage and full load
09. Inrush Current: 30A Typical at 115VAC input and 60A typical at 230VAC input
10. Switching Frequency: 65 KHz typical

B) PROTECTION

01. Over-Voltage: Electronically Protected Zener clamp across the output
02. Short Circuit: Electronically Protected unit will auto recover upon removal of fault
03. Input Protection: Input line fusing

C) SAFETY

01. Dielectric Withstand Voltage: 4242Vdc from primary to secondary
02. Earth Leakage Current: <3.5 mA at 240Vac input voltage
03. Earth continuity test: <0.1 Ohm or < 0.2 Ohm when with a non-detachable Power Supply cord, Class I Only
04. ROHS 2: Complies with EU 2011/65/EU and China GB/T26572-2011

D) OTHER:

01. MTBF: 200,000 Hours @ 25°C ambient temperature
02. Operating Temperature: 0°C to 40°C ambient temperature
03. Humidity: 0% to 90% relative humidity
04. Storage Temperature: -10°C to 80°C

E) ENCLOSURE

01. Housing: High impact plastic, 94V0 polycarbonate, non-vented
02. Size: 50.0*80.6*31.1 +/-1.0 mm
03. Markings: Label and/or Pad Printed and/or Molded in the case

Delivering leading edge, innovative power solutions for more than 30 years....

Model:GT-46181-18VV-T3A

September 19, 2019

DERATING CURVE

**Typical External
Power Supply Derating Curve**

(For Efficiency Level V and Efficiency Level VI Products)

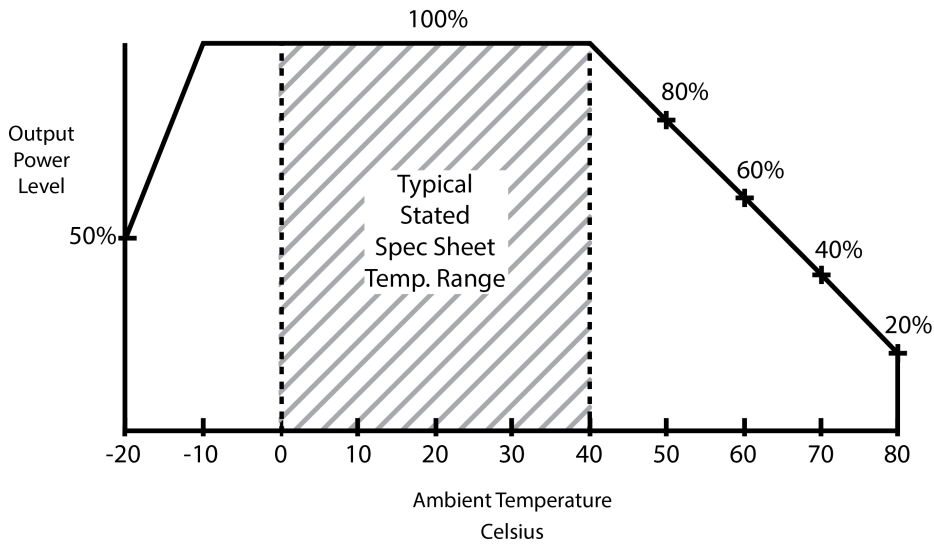

Delivering leading edge, innovative power solutions for more than 30 years....

Model:GT-46181-18VV-T3A

September 19, 2019

Input Configuration

Description IEC 60320/C6 AC Inlet Connector, Class I, Earth Ground (aka "Mickey Mouse")

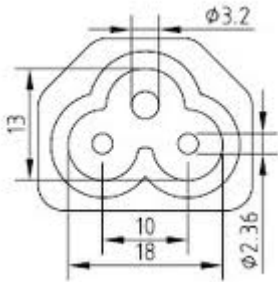

Mates with IEC 60320/C5 Plug

Standard International IEC 320/C5 Cordsets

Below are standard cordsets which are "not included" (unless stated above); these can be purchased separately or package with the power supply. Contact your Sales Engineer if the style required is not shown below. Many more available in different lengths, colors or cable material.

Part Number / Link	Country	Plug	Connector	Length (mm)	Length (ft)
3021066F712(R)	N. American (Type B)	NEMA 5-15P	IEC 320/C5	1880	6
1191068F0712(R)	N. American (Type B)	NEMA 5-15P Hospital	IEC 320/C5	2459	8
2194262M0712(R)	Argentina (Type I)	IRAM 2073	IEC320/C5	2050	6.7
2064262M0712(R)	Australian (Type I)	AS3112 / 3 PRONG	IEC 320/C5	2000	6.6
204B4262M0712(R)	Brazil (Type N)	BRAZIL	IEC 320/C5	2000	6.6
6023592M5712(R)	China (Type I)	CCC GR2099	IEC 320/C5	2500	8
23144262M0712(R)	Europe (Type E)	CEE 7/7	IEC 320/C5	2050	6.6
2313K3432M0712(R)	Korea (Type F)	KS C 8305	IEC 320/C5	2000	6.6
205IN4262M0712(R)	India (Type D)	India IS 1293 (also known as IA16A3 or BS546)	IEC320/C5	2000	6.6

Delivering leading edge, innovative power solutions for more than **30** years....

Model:GT-46181-18VV-T3A

September 19, 2019

377C4262M0712(R)	Israel (Type H)	ISL	IEC320/C5 2050	6.7
23024262M0712(R)	Italy (Type L)	CEI 23-16/VII	IEC 320/C5 2000	6.6
3003316F0712(R)	Japan (Type B)	JIS 8303 / 3 PINS	IEC 320/C5 1830	6
3021066F0712ULPSE(R)	Japan / USA (Type B)	JIS 8303 / 3 PINS + NEMA 5-15P	IEC 320/C5 1830	6
2054262M0712(R)	S. Africa (Type D)	South Africa SABS164-1 (6A type plug)	IEC320/C5 2050	6.7
2084262M0712(R)	S.Africa (Type M)	South Africa SABS164-1 (16A type plug)	IEC 320/C5 2000	6.6
23214262M0712(R)	Switzerland (Type J)	SEV 1011 (EL 203)	IEC 320/C5 2000	6.6
3003316F0712(R)	Taiwan (Type B)	BSMI	IEC 320/C5 2000	6.6
6104262M0712(R)	UK, Hong Kong, Singapore, Gulf States (Type G)	BS1363	IEC 320/C5 2000	6.6

Delivering leading edge, innovative power solutions for more than 30 years....

Model:GT-46181-18VV-T3A

September 19, 2019

Output Configuration

Common output connector options:

 L Type (Coaxial
5.5x2.5mm plug)

 C Type (Coaxial
5.5x2.1mm plug)

 K Type (Coaxial
3.5x1.3mm plug)

 LL Type (5.5x2.5mm
Locking 760k type)

 CL Type (5.5x2.1mm
Locking S761k type)

 ML2 Type (Molex
housing 43025-0200)

YL3 Type (KPPX-3P)



YL4 Type (KPPX-4P)

 EJ1/2/3/4/5 (EIAJ
RC-5320A type
connectors)

MSB Type (Micro USB)

 USBC Type (USB Type
C)

 Inquire for custom
design

 For a comprehensive list of options, [click here](#)











Contact GlobTek for your specific requirements or custom solutions.

Delivering leading edge, innovative power solutions for more than 30 years....

Model:GT-46181-18VV-T3A

September 19, 2019

Approvals

Logo	Description
No Logo Applicable No Logo	EU 230V CoC Tier 2, 278/2009, Mar 2014 CB Report IEC 60950-1:2005 (Second Edition) + Am 1:2009 + Am 2:2013 (GT-46181 only)
 仅适用于在海拔2000m以下地区使用 仅适用于在亚热带气候条件下使用	CCC to GB4943.1-2011 GB9254-2008 GB17625.1-2012
	CE Mark: tested to comply with EN55022:2006/A1:2007 Class B, EN610003-2, EN610003-3 including EN61000-4-2, EN61000-4-3, EN61000-4-4, EN61000-4-5, EN61000-4-6N EN61000-4-11; EMI: Complies with EN55011 CLASS B and FCC Part 15B - On label or Molded in case
	CHINA SJ/T 11364-2014, China RoHS Chart: http://en.globtek.com/globtek-rohs.php
 LISTED 4MU8 E170507	UL60950-1, cULus to UL 60950-1, 2nd Edition, 2014-10-14 and CSA C22.2 No. 60950-1-07, 2nd Edition, 2014-10
	Declaration ДС № EAЭC N RU Д-US.KA01.B.10453_19 Custom Union of Russia, Belarus and Kazakhstan http://www.globtek.com/redirect/?loc=gost-certificate-eac-declaration
	Compliance of this power supply with FCC Part 15, Class B has been demonstrated with a standard output load. The FCC law stipulates that system-level testing is required to demonstrate compliance with the FCC emission limits with the actual system load.
CAN ICES-3(B)/NMB-3(B)	Compliance of this PSU with Industry Canada, Class B demonstrated with a standard output load. The ICES law stipulates that system-level testing is required to demonstrate compliance with the ICES-3 emission limits with the actual system load.
	Indoor Use Only - Mark is on the label or Molded in the case
IP40	Ingress Protection: ?IP40 to IEC60529:2001 Protection against granular foreign bodies
 GlobTek, Inc.	JAPAN TUV R-PSE, Cert. No. JD 50314327, to J60950-1(H26) , J55022(H22),J3000(H25)[15V or less]. Please reference the following website for guidelines on PSE regulations: http://en.globtek.com/importing-ite-and-medical-power-supplies-ac-adaptors-to-japan/
 GlobTek, Inc.	JAPAN TUV R-PSE, Cert. No. JD 50314327, to J60950-1(H26) , J55022(H22),J3000(H25)[DC15?30V]. Please reference the following website for guidelines on PSE regulations: http://en.globtek.com/importing-ite-and-medical-power-supplies-ac-adaptors-to-japan/
EFFICIENCY LEVEL VI	Efficiency: complies to section 301 of Energy Independence and Security Act (EISA) complies with Energy Star tier 2 (North America), ECP tier 2 (China), MEPS tier 2 (Australia), Code of Conduct (Europe)
LPS	Limited Power Source
 GlobTek, Inc.	JAPAN TUV Rheinland-PSE GlobTek Inc to J60950-1(H26) , J55022(H22),J3000(H25).Please follow the procedure listed in the following link for proper import to Japan: http://en.globtek.com/importing-to-japan.php .

Delivering leading edge, innovative power solutions for more than **30** years....

Model:GT-46181-18VV-T3A

September 19, 2019

**SAA-160882-EA**RCM certificate SAA-160882-EA; Australia and New Zealand Regulatory Compliance, Mark (<http://rcm.standards.org.au/rcmfaq/rcmfaq.htm>)

RoHS



intertek

Specifications of directive 2011/65/EU Annex VI (ROHS-2) with amendment 2015/863-EU (ROHS-3)
<http://www.ce-mark.com/Rohs%20final.pdf>S-Mark Certificate EN 60950-1:2006 + A11:2009 + A1:2010 + A12:2011 +A2:2013 (
<http://www.intertek.com/marks/s/>)

10276

Ukraine UKRSepro (Document: www.globtek.com/html/iso_certificates/GT_Ukraine.pdf)

Japan: Voluntary Control Council for Interference (VCCI)

WEEE: Complies with EU 2012/19/EU (http://ec.europa.eu/environment/waste/weee/index_en.htm)
Mark is on the label or Molded in the case