

Delivering leading edge, innovative power solutions for more than **30** years....

Model:GT-96300-36VV-T3-PP

July 16, 2019

GT-96300-36VV-T3-PP

Information

Model Number GT-96300-36VV-T3-PP

Description GT-96300-36VV-T3-PP, PoE, Passive Power Injector, Desktop/External, Single Port Passive Power Over Ethernet Midspan (Passive/Dumb PoE PSE) Power Supply AC Adaptor, , Input Rating: 100-240V~, 50-60 Hz, IEC 60320/C14 AC Inlet Connector, Class I, Earth Ground, Output Rating: 36 Watts, Power rating with convection cooling (W) , 18-56V in 0.1V increments, Approvals: CB 62368; Patent US9838207B2; EAC; CCC; PSE; PSE; CE; China RoHS; Class I; Level VI; RoHS; Ukraine; VCCI; WEEE; RCM; CB 60335;

Model Picture



Agency

Documents <http://www.globtek.info/certs/GT-96300-POE/>

CE

EC-Declaration https://www.globtek.com/pdf/ec_declaration/a0Oa000000MnJfREAV

RoHS/RoHS2

Declaration https://www.globtek.com/pdf/rohs_cert/a0Oa000000MnJfREAV

REACH

Declaration https://www.globtek.com/pdf/iso_certificates/REACH.pdf

Conflict

Minerals <https://www.globtek.com/pdf/conflict-minerals.pdf>

Declaration

Delivering leading edge, innovative power solutions for more than **30** years....

Model:GT-96300-36VV-T3-PP

July 16, 2019

Model Parameters

Type	Desktop/External
Technology	Single Port Passive Power Over Ethernet Midspan (Passive/Dumb PoE PSE) Power Supply AC Adaptor
Category	PoE, Passive Power Injector
Input Voltage	100-240V~, 50-60 Hz
I/P Amps (A)	1.0A
Wattage (W)	36.0
Vout Range (V)	18-56
Efficiency Level	VI
Ingress Protection	IP40
Size (mm)	107*55*36

Delivering leading edge, innovative power solutions for more than 30 years....

Model:GT-96300-36VV-T3-PP

July 16, 2019

ENCLOSURE

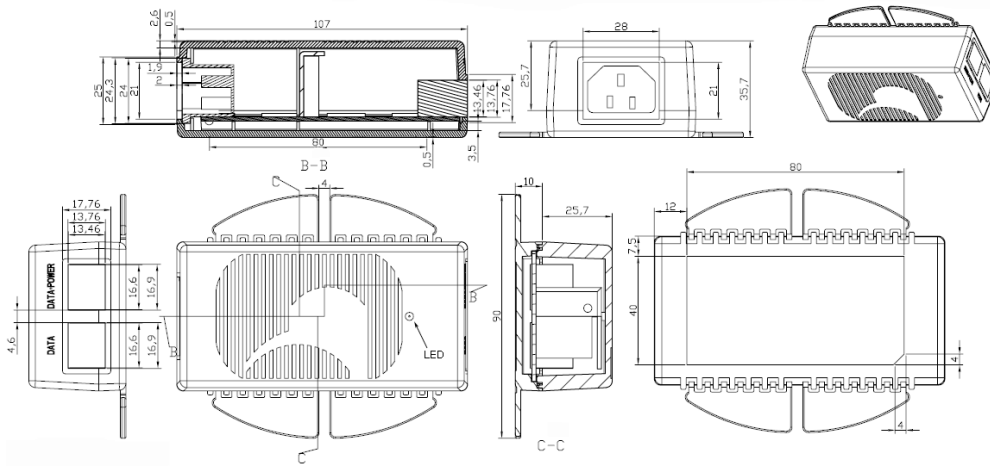

Delivering leading edge, innovative power solutions for more than **30** years....

Model:GT-96300-36VV-T3-PP

July 16, 2019

RATING TABLE

Model Number	Voltage	Amps(A)	Watts(W)	RFQ
GT-96300-2719.5-1.5-T3-PP	18 V	1.5	27.00	RFQ
GT-96300-3224-T3-PP	24 V	1.333	31.99	RFQ
GT-96300-3636-T3-PP	36 V	1	36.00	RFQ
GT-96300-3648-T3-PP	48 V	0.75	36.00	RFQ
GT-96300-3656-T3-PP	56 V	0.642	35.95	RFQ

Delivering leading edge, innovative power solutions for more than 30 years....

Model:GT-96300-36VV-T3-PP

July 16, 2019

SPECIFICATIONS

GlobTek's 18W and 36W Passive Power over Ethernet Midspan Injectors offers cost effective and reliable solution for remote powering of specialized non-standard Ethernet Powered Devices requiring up to 36 Watts over existing network infrastructure. These Passive Injectors are configured to provide 18 or 36 watts of power over two pairs (4,5 + and 7,8 -) per IEEE 802.3 defined wires.

When the load device is connected, GlobTek's Passive PoE Injector will immediately source power to the Powered Device.

GlobTek's 56V Passive PoE Injectors are designed to function with and provide power to any IEEE 802.3af or 802.3at PoE device.

For specialized applications Globtek can also provide lower output voltage models between 18V and 54V with reduced circuit complexity, these are referred to as our Simple Power over Ethernet Injector products.

MAIN FEATURES

- Cost Effective Passive PoE, supplies continuous power without requiring handshaking communications
- Output can source up to 18W or 36W at 18V, 24V, 36V, 48V, 54V or 56V
- Withstands high energy EMI Immunity events without going into latched shutdown state
- Short Circuit and Overload Protection protects Ethernet cabling if Splitter has a Short Circuit
- Green LED Indicates Output Power Availability
- Passive PoE models can transfer 10/100/1000 BaseT Data Rates (Gigabit compatible)
- Simple, Low Cost PoE models can transfer 10/100 BaseT Data Rates
- Universal Input Power from 100Vac to 240Vac
- Green Design: Compliant to DoE Efficiency level VI requirement
- Full Protection for Over Voltage and Current
- Compact 104 x 54 x 40 mm (w/o MTG Flange)

APPLICATIONS

- Custom Ethernet Power Distribution Architecture
- Network Security Cameras
- Point of Sales
- Industrial Controllers
- Electronic Time Card Readers
- Building Security Systems
- Network Camera with Pan, Tilt and Zoom Features
- Electronic Signs
- RFID Readers
- Motion Sensors
- HVAC Controllers
- Magnetic Card Readers
- Digital Time clock

A) ELECTRICAL SPECIFICATIONS:

INPUT

Input Range: 90-264 Vac (85-264Vac @ 85% of rated output power)

Input Line Frequency: 47-63Hz

Input Current:< 1A RMS @ 90Vac Full Load for 36W

< 0.6A RMS @ 90Vac Full Load for 18W

Inrush Current: 30/60A max at 115/230Vac

No load Power: < 100mW

Efficiency: > 87.4%, 4 Point Avg efficiency. Typical at Full Load for 36W

> 85.0%, 4 Point Avg efficiency. Typical at Full Load for 18W

Turn on-delay: 1 Second Typical @ 115Vac

PROPRIETARY INFORMATION

PROPRIETARY OF GLOBTEK, INC. ANY REPRODUCTION, DISCLOSURE OR USE OF THIS DRAWING, IN WHOLE OR IN PART, IS HEREBY PROHIBITED EXCEPT AS SPECIFIED IN WRITING BY GLOBTEK, INC.

<http://en.globtek.com/datasheet/id/a00a000000MnJFR>

Delivering leading edge, innovative power solutions for more than 30 years....

Model:GT-96300-36VV-T3-PP

July 16, 2019

Input Line Protection: MOV Transient protected.
Hold-up time: 8ms typical at nominal input voltage and full load
Touch current at output: <100uA
Earth Leakage current at input: <100uA
Isolation: Input to Output, 3000 VAC

OUTPUT

Power Injection Pins: 4&5 for V+ and 7&8 for Common
Port Voltage: 56V standard, 18V to 54V optional
Port Power: 18W or 36W Max
Port Voltage Regulation: +/-3%, and less than 57Vdc
Port Voltage Ripple: 100mVpp max

B) ENVIRONMENTAL

Temperature: Operating, -10C to 40C
Storage, -30C to 80C
Humidity: 0% to 95% Relative Humidity, Non-Condensing
Altitude: Operating, Up to 5000M

C) MECHANICALS / ENCLOSURE

Housing: High impact plastic, 94V0 polycarbonate, non-vented
Markings: Label and/or Pad Printed and/or Molded in the case
Dimensions: 104*54*40 mm (w/o MTG Flange)
Weight: 0.35 Lb, 155 gr.
AC Input mechanical options: Desktop C6, C8, C14 or C18 IEC Inlet.
Hybrid option (Desktop or Changeable Blade Wall Plug-in) Class I or Class II input
Data and Data+Power Connector: Fully Shielded RJ45

D) EMISSIONS and IMMUNITY

Emission: Meets FCC Class B Part 15, EN55022 Class B
Immunity: Meets the following;
EN610000-6-2 (Industrial Level Immunity Compliance, extended levels shown in parenthesis)
EN 61000-4-2 ESD (+/-18KV Air, +/-8KV Contact, criteria A) (+/-20KV Air, +/-10KV Contact, criteria B)
EN 61000-4-3 Radiated Immunity
EN 61000-4-4 EFT (+/-2.5KV, criteria A) (+/-4KV, criteria B)
EN 61000-4-5 Surge (+/-2KV Line-Line, +/-4KV Line to Gnd, criteria A)
EN 61000-4-6 Conducted Susceptibility
EN 61000-4-11 Voltage Dips and Interrupts
EN 61000-3-2 Harmonics, Class A

E) SAFETY APPROVALS

Compliant Safety Standards: See listings at end of this drawing for specifics

F) INTEROPERABILITY: Passive and Simple 48V and 56V models work with all types of AF and AT Splitters and PoE appliances with appropriate input power requirements

G) SPECIAL OPTIONS

1. Custom Markings
2. High Rel PCB laminate with Plated through Holes for IPC610 Class 2 Compliance
3. Special Housing Color

Delivering leading edge, innovative power solutions for more than 30 years....

Model:GT-96300-36VV-T3-PP

July 16, 2019

4. Reduced Output Voltage, 18V to 54V
36W PoE Injector, Ethernet InterOperability and Compatibility Testing

 Injector tested: *Model GT-96300-3656*, rated 36W output, 56Vdc, IEEE802.3-2009 at Compliant

Note, assuming 80% eff splitter, max Pout = 28.8W (28.8/36 = 0.8)

Splitter Model Used	Splitter Description	Splitter O/P Power Rating	Splitter Load During Testing
GlobTek GT-91087	5V, af type	8W	7.5W
PowerDSIne PD-AS-601/5	5V, af type	10W	
Linksys POEES5	5V, af type	10W	
Axis 5008-001-02	5V, af type	10W	
PowerDSIne PD-AS-701/12	12V, at type	24W	24W
Phihong POE21-120-R	12V, at type	21W	21W
Cisco 7970 Series Phone	IP Phone, af type	Input to Phone rating 48V, 0.38A	

* For 24W-30W output power Splitters using Data Link Layer Classification, contact GlobTek for option availability.

100BaseT/1000 Base T network digital transmission testing

(During testing ethernet communications is passed thru Injector and then Splitter and then to a computer)

 Injector tested: *Model GT-96300-3656*, rated 36W output, 56Vdc, IEEE802.3-2009 at Compliant

Injector is Gigabit designed and tested, to 100 Base T and 1000 Base T

Splitter Model Used	Splitter Description	P/F	Notes:
Axis 5008-001-02	100 Base T rating	P	Limited bandwidth splitter
PowerDSIne PD-AS-701/12	1000 Base T rating	P	Full bandwidth splitter

Delivering leading edge, innovative power solutions for more than 30 years....

Model:GT-96300-36VV-T3-PP

July 16, 2019

DERATING CURVE

**Typical External
Power Supply Derating Curve**

(For Efficiency Level V and Efficiency Level VI Products)

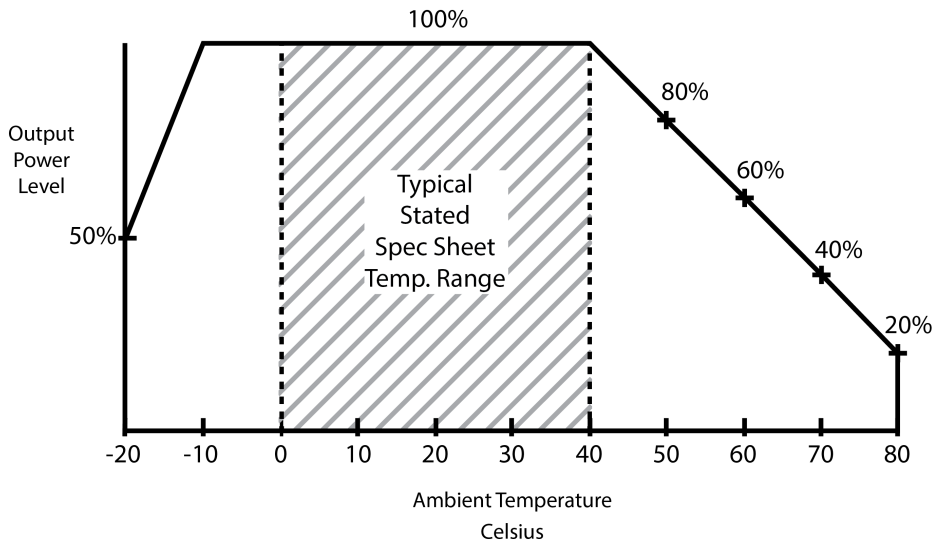

Delivering leading edge, innovative power solutions for more than 30 years....

Model:GT-96300-36VV-T3-PP

July 16, 2019

Input Configuration

Description IEC 60320/C14 AC Inlet Connector, Class I, Earth Ground

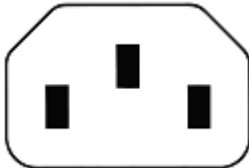

Mates with IEC 60320/C13 Plug

Optional Locking IEC60320 Receptacle and cord option available on some models by request.:



[Standard International IEC 320/C13 Cordsets](#)

Below are standard cordsets which are "not included" (unless stated above); these can be purchased separately or packaged with the power supply. Contact your Sales Engineer if the style required is not shown below. Many more available in different lengths, colors or cable material.

Stock Power Supply Cords

Part Number/ Link	Country	Plug	Termination	Length (mm)	(Ft)
3021457F701(R)	N. American (Type B)	NEMA 5-15P	IEC 320/C13	2150	7
1191068F0701(R)	N. American (Type B)	NEMA 5-15P Hospital	IEC 320/C13	2459	8
2194272M5701-T(R)	Argentina (Type I)	IRAM 2073	IEC 320/C13	2500	8
5502022M5701A(R)	Australian (Type I)	AS3112 / 3 PRONG	IEC 320/C13	2500	8
204B4272M5701(R)	Brazil (Type N)	BRAZIL	IEC 320/C13	2500	8
6023602M5701(R)	China (Type I)	CCC GR2099	IEC 320/C13	2500	8
G8014272M5701(R)	Danish (Type K)	AFSNIT SECTION 107-2-D1	IEC 320/C13	2500	8
23144272M5701-T(R)	Europe (Type E)	CEE 7/7	IEC 320/C13	2500	8
205IN4272M5701(R)	India (Type D)	India IS 1293 (also known as IA16A3 or BS546)	IEC 320/C13	2500	8
208IN4272M5701(R)	India (Type M)	India IS 1293 (also known as IA16A3 or BS546)	IEC320/C13	2500	8
377C4272M5701(R)	Israel (Type H)	ISL 377C	IEC 320/C13	2500	8
23024272M5701(R)	Italy (Type L)	CEI 23-16/VII	IEC 320/C13	2500	8
3003339F701(R) [3x1.25mm2]	Japan (Type B)	JIS 8303 / 3 PINS	IEC 320/C13	2500	8

Delivering leading edge, innovative power solutions for more than **30** years....

Model:GT-96300-36VV-T3-PP

July 16, 2019





3003068F2701-HK(R) [3 x 2.0mm2]						
302J115J6F0701J(R)	Japan / North America (Type B – 12A)	JIS 8303 / 3 PINS and NEMA 5-15P (PSE and UL/CUL appr)	IEC 320/C13	1830	6	
302J104J6F0701J(R)	Japan / North America (Type B – 15A)	JIS 8303 / 3 PINS and NEMA 5-15P (PSE and UL/CUL appr)	IEC 320/C13	1830	6	
2313K3432M5701(R)	Korea (Type F)	KS C 8305	IEC 320/C13	2500	8	
5804272M5701(R)	Russia (Type F)	GOST 7396	IEC 320/C13	2500	8	
2084272M5701(R)	South Africa (Type M)	South Africa SABS164-1 (16A type)	IEC 320/C13	2500	8	
23214272M5701(R)	Switzerland (Type J)	SEV 1011	IEC 320/C13	2500	8	
3003322M5701(R)	Taiwan (Type B)	BSMI	IEC 320/C13	2500	8	
PZ0800100-2M5BK13H(R)	UK, Hong Kong, Singapore, Gulf States (Type G)	BS 1363A	IEC 320/C13	2500	8	
7055002M5701A(R)	International	IEC 320 C14-C13	IEC 320/C13	2500	8	

Delivering leading edge, innovative power solutions for more than 30 years....

Model:GT-96300-36VV-T3-PP

July 16, 2019

Approvals

Logo	Description
No Logo Applicable	IEC 60335-1:2010 (Fifth Edition) incl. Corr. 1:2010 and Corr. 2:2011 + A1:2013
No Logo Applicable	CB for IEC 62368-1:2014 (Second Edition)
	CCC model meets both Tropical and Altitude up to 5000M GB4943.1-2011; GB/T9254-2008; GB17625.1-2012
	CE Certification
	CHINA SJ/T 11364-2014, China RoHS Chart: http://en.globtek.com/globtek-rohs.php
	Declaration # EA3C N RU Д-US.AД75.B.01052 Custom Union of Russia, Belarus and Kazakhstan http://www.globtek.com/redirect/?loc=gost-certificate-eac-declaration
 GlobTek, Inc.	JAPAN TUV R-PSE, Cert. No. JD 50313285, to J60950-1(H26) , J55022(H22),J3000(H25)[DC15? 30V]. Please reference the following website for guidelines on PSE regulations: http://en.globtek.com/importing-ite-and-medical-power-supplies-ac-adaptors-to-japan/
 GlobTek, Inc.	JAPAN TUV R-PSE, Cert. No. JD 50313285, to J60950-1(H26) , J55022(H22),J3000(H25)[DC30? 60V]. Please reference the following website for guidelines on PSE regulations: http://en.globtek.com/importing-ite-and-medical-power-supplies-ac-adaptors-to-japan/
EFFICIENCY LEVEL 	Efficiency: complies to section 301 of Energy Independence and Security Act (EISA) complies with Energy Star tier 2 (North America), ECP tier 2 (China), MEPS tier 2 (Australia), Code of Conduct (Europe)
Patent US9838207B2	Protected by US and international patents, US patent number US9838207B2
	RCM certificate SAA-161679-EA; Australia and New Zealand Regulatory Compliance, Mark (http://rcm.standards.org.au/rcmfaq/rcmfaq.htm
RoHS	Specifications of directive 2011/65/EU Annex VI (ROHS-2) with amendment 2015/863-EU (ROHS-3) http://www.ce-mark.com/Rohs%20final.pdf
 10276	Ukraine UKRSepr (Document: www.globtek.com/html/iso_certificates/GT_Ukraine.pdf)
	Japan: Voluntary Control Council for Interference (VCCI)
	WEEE: Complies with EU 2012/19/EU (http://ec.europa.eu/environment/waste/weee/index_en.htm) Mark is on the label or Molded in the case