

Delivering leading edge, innovative power solutions for more than **30** years....

Model:GTM21089-WVVV-W3E

May 20, 2019

GTM21089-WVVV-W3E

Information

Model Number GTM21089-WVVV-W3E

Description GTM21089-WVVV-W3E, Medical Power Supply, Wall Plug-in, Regulated Switchmode AC-DC Power Supply AC Adaptor, , Input Rating: 100-240V~, 50-60 Hz, EURO (SCHUKO) PLUG CEE 7/4, 2 PRONGS W/GROUND, Output Rating: 19 Watts, Power rating with convection cooling (W) , 3.3-48V in 0.1V increments, Approvals: China RoHS; CE; Book 60601; IP40; Class II with FE; WEEE; VCCI; Ukraine; RoHS;

Model Picture

Agency

Documents <http://www.globtek.info/certs/GTM21089/>

CE

EC-Declaration https://www.globtek.com/pdf/ec_declaration/a0Oa000000MnH72EAF

RoHS/RoHS2

Declaration https://www.globtek.com/pdf/rohs_cert/a0Oa000000MnH72EAF

REACH

Declaration https://www.globtek.com/pdf/iso_certificates/REACH.pdf

Conflict

Minerals

Declaration <https://www.globtek.com/pdf/conflict-minerals.pdf>

Declaration

Delivering leading edge, innovative power solutions for more than **30** years....

Model:GTM21089-WWVW-W3E

May 20, 2019

Model Parameters

Type	Wall Plug-in
Technology	Regulated Switchmode AC-DC Power Supply AC Adaptor
Category	Medical Power Supply
Input Voltage	100-240V~, 50-60 Hz
I/P Amps (A)	0.5A MAX
Wattage (W)	19.0
Vout Range (V)	3.3-48
Efficiency Level	Meets/Exceeds for Medical
Ingress Protection	IP40
Size (mm)	74*49*40.5

Delivering leading edge, innovative power solutions for more than 30 years....

Model:GTM21089-WVVV-W3E

May 20, 2019

ENCLOSURE

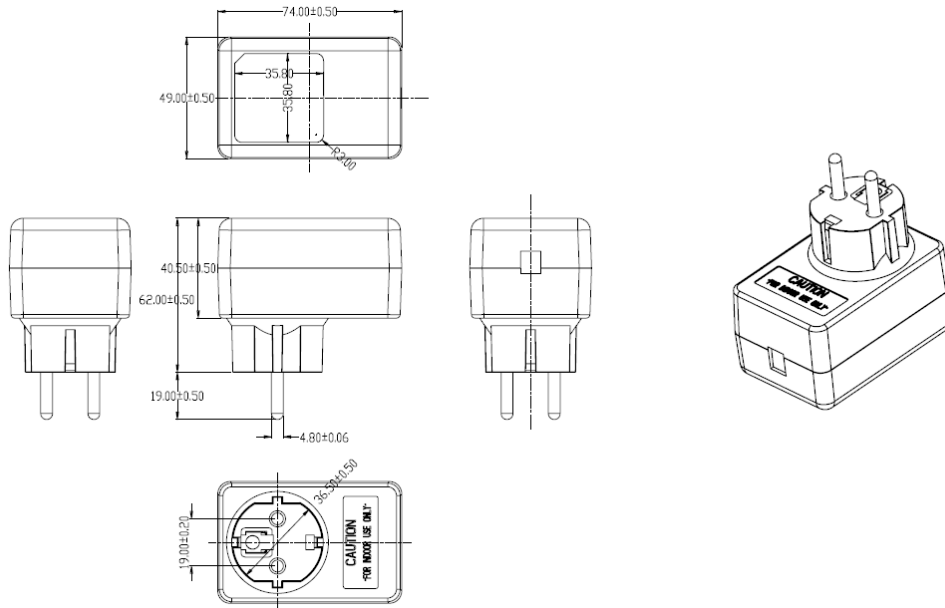

Delivering leading edge, innovative power solutions for more than **30** years....

Model:GTM21089-WVVV-W3E

May 20, 2019

RATING TABLE

Model Number	Voltage	Amps(A)	Watts(W)	RFQ
GTM21089-1509-W3E9	V	1.67	15.03	RFQ

Delivering leading edge, innovative power solutions for more than 30 years....

Model:GTM21089-WVVV-W3E

May 20, 2019

SPECIFICATIONS

A) ELECTRICAL SPECIFICATIONS:

01. Input Voltage: Specified 90-264 Vac, Nameplate rated: 100-240Vac
02. Input Frequency: Specified 47-63 Hz, Nameplate rated 50-60Hz
03. Output Regulation: +/- 5% measured at the output connector, no minimum load required
04. Line Voltage Regulation: +/- 1% typical measured at full load
05. Output Ripple (Vp-p): 1% or 100 mV whichever is greater, measured at 20 MHz bandwidth with 0.1 uf ceramic capacitor in parallel with a low impedance 47 uf electrolytic capacitor connected at the end of the output connector
06. Turn-ON/OFF: 5% maximum, 1 mS typical recovery time for 25% step load
07. Turn-ON Delay: 1 Sec, typical
08. Hold-Up Time: 10 mS typical @ nominal input voltage and full load
09. Inrush Current: 30A maximum cold start @ 240Vac input
10. Switching Frequency: 100 KHz typical, varies with line and load
11. Efficiency: 75% typical
12. Input protection: Input line and neutral fusing

B) PROTECTION

01. Over-Voltage: Limited via crowbar method
02. Short Circuit: Momentary short circuit protected with auto recovery upon removal of short
03. Earth Leakage Current: Did not exceed 5 mA in NORMAL CONDITION and 10 mA in SINGLE FAULT CONDITION
04. Earth continuity test: <0.1 Ohm or < 0.2 Ohm when with a non-detachable Power Supply cord
05. Touch Current: Did not exceed 100uA NC(Normal condition) 500uA SFC(single fault condition)
06. Over-load: Hiccup with auto recovery
07. Input Protection: Input line and neutral fusing

C) SAFETY

01. Dielectric Withstand Voltage: 5656vdc from primary to secondary
02. Type of protection against electric shock: class II with function earth
03. Degree of protection against electric shock: not classified (no applied part)
04. Degree of protection Against ingress of water: IPX0 (ordinary)
05. Degree of safety of application in the presence of flammable anesthetic: not evaluated Mode of operation: continuous
06. Earth Leakage Current: Did not exceed 5 mA in NORMAL CONDITION and 10 mA in SINGLE FAULT CONDITION
07. Touch Current: Did not exceed 100uA NC(Normal condition) 500uA SFC(single fault condition)

D) OTHER:

01. MTBF: 200,000 Hours @ 25°C ambient temperature
02. Operating Temperature: 0°C to 40°C ambient temperature
03. Storage Temperature: -10°C to 80°C
04. Humidity: 0% to 90% relative humidity
05. ROHS 2: Complies with EU 2011/65/EU and China SJ/T 11363-2006

E) ENCLOSURE

1. Upper Housing: High impact plastic, 94V0 polycarbonate, non-vented
2. Lower Housing: High impact plastic, 94V0 polycarbonate, non-vented
3. Size: 74*49*40.5 ±0.5 mm

Delivering leading edge, innovative power solutions for more than **30** years....

Model:GTM21089-WVVV-W3E

May 20, 2019

DERATING CURVE

Delivering leading edge, innovative power solutions for more than **30** years....

Model:GTM21089-WVVV-W3E

May 20, 2019

Input Configuration

DescriptionEURO (SCHUKO) PLUG CEE 7/4, 2 PRONGS W/GROUND

Delivering leading edge, innovative power solutions for more than 30 years....

Model:GTM21089-WVVV-W3E

May 20, 2019

Output Configuration

Common output connector options:

 L Type (Coaxial
5.5x2.5mm plug)

 C Type (Coaxial
5.5x2.1mm plug)

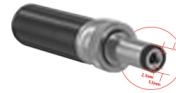
 K Type (Coaxial
3.5x1.3mm plug)

 LL Type (5.5x2.5mm
Locking 760k type)

 CL Type (5.5x2.1mm
Locking S761k type)

 ML2 Type (Molex
housing 43025-0200)

YL3 Type (KPPX-3P)



YL4 Type (KPPX-4P)

 EJ1/2/3/4/5 (EIAJ
RC-5320A type
connectors)

MSB Type (Micro USB)

 USBC Type (USB Type
C)

 Inquire for custom
design

 For a comprehensive list of options, [click here](#)









Contact GlobTek for your specific requirements or custom solutions.

Delivering leading edge, innovative power solutions for more than 30 years....

Model:GTM21089-WVVV-W3E

May 20, 2019

Approvals

Logo	Description
	Attention Mark / Refer to operating manual for operating and service instructions
	60601-1 3rd Operating Instructions
	CE Mark: tested to comply with EN61000-3-2, EN61000-3-3 and EN50082-1, including EN61000-4-2, EN61000-4-3, EN61000-4-4, EN61000-4-5, EN61000-4-6, EN61000-4-8, EN61000-4-11, EN61001-1-2-2007 EMI: Complies with EN55011 CLASS B and FCC Part 15 B
	CHINA SJ/T 11364-2014, China RoHS Chart: http://en.globtek.com/globtek-rohs.php
	Class II with Functional Earth
	Indoor Use Only - Mark is on the label or Molded in the case
IP40	Ingress Protection: ?IP40 to IEC60529:2001 Protection against granular foreign bodies (with I/P cord)
RoHS	Specifications of directive 2011/65/EU Annex VI (ROHS-2) with amendment 2015/863-EU (ROHS-3) http://www.ce-mark.com/Rohs%20final.pdf
 10276	Ukraine UKRSepro (Document: www.globtek.com/html/iso_certificates/GT_Ukraine.pdf)
	Japan: Voluntary Control Council for Interference (VCCI)
	WEEE: Complies with EU 2012/19/EU (http://ec.europa.eu/environment/waste/weee/index_en.htm) Mark is on the label or Molded in the case