

Delivering leading edge, innovative power solutions for more than **30** years....

Model:GT-83083-0505 (F-Blade)

September 19, 2019

GT-83083-0505 (F-Blade)

Information

Model Number GT-83083-0505 (F-Blade)

Description GT-83083-0505 (F-Blade), ITE Power Supply, Wall Plug-in, Regulated Switchmode AC-DC Power Supply AC Adaptor, , Input Rating: 100-240V~, 50-60Hz, Blade Options for F- Series Wall Plug-in Power Supplies, Output Rating: 5 Watts, Power rating with convection cooling (W) , 5VV in 0.1V increments, Approvals: WEEE; CB 60950; VCCI; PSE; LPS; Level VI; Double Insulation; China RoHS; CE; cULus; SIQ;

Model Picture



Agency Documents CE <http://www.globtek.info/certs/GT-83083-USB-W2Z/>
EC-Declaration https://www.globtek.com/pdf/ec_declaration/a0Oa000000MmPIkEAN
RoHS/RoHS2 Declaration https://www.globtek.com/pdf/rohs_cert/a0Oa000000MmPIkEAN
REACH Declaration https://www.globtek.com/pdf/iso_certificates/REACH.pdf
Conflict Minerals Declaration <https://www.globtek.com/pdf/conflict-minerals.pdf>

Delivering leading edge, innovative power solutions for more than **30** years....

Model:GT-83083-0505 (F-Blade)

September 19, 2019

Model Parameters

Type	Wall Plug-in
Technology	Regulated Switchmode AC-DC Power Supply AC Adaptor
Category	ITE Power Supply
Input Voltage	100-240V~, 50-60Hz
I/P Amps (A)	0.2A
Wattage (W)	5.0
Vout Range (V)	5V
Efficiency Level	VI
Ingress Protection	IPX0
Size (mm)	47.3(L) *34.8(W) *26.7(H)

Delivering leading edge, innovative power solutions for more than **30** years....

Model:GT-83083-0505 (F-Blade)

September 19, 2019

ENCLOSURE

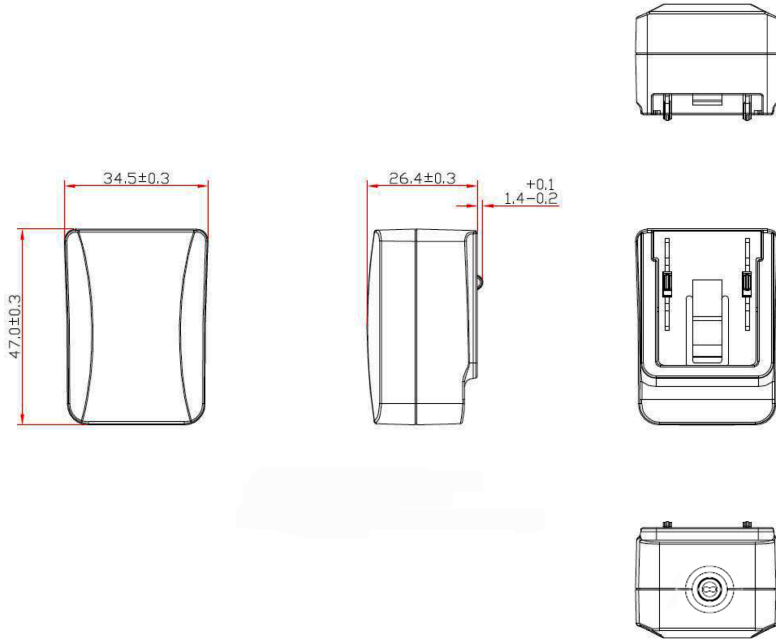

Delivering leading edge, innovative power solutions for more than **30** years....

Model:GT-83083-0505 (F-Blade)

September 19, 2019

RATING TABLE

Model Number	Voltage	Amps(A)	Watts(W)	RFQ
GT-83083-0505	V	1	5.00	RFQ

SPECIFICATIONS**A) ELECTRICAL SPECIFICATIONS:**

01. Input Voltage: Specified 90-264 Vac, Nameplate rated: 100-240Vac
02. Input Frequency: Specified 47-63 Hz, Nameplate rated 50-60Hz
03. Line Regulation: $\pm 5\%$
04. Load regulation: $\pm 5\%$
05. Ripple and Noise (Vp-p): 300 mVp-p maximum, At 20 MHz, and output parallel with 0.1uF & 10uF capacitors to ground, Temperature at 25 °C, and nominal AC input voltage
06. Average Efficiency: 73.77% minimum , At nominal input voltage average Efficiency meet CEC VI
07. Turn-ON Delay: 3 Seconds maximum

B) PROTECTION

01. Over-Voltage: 10V maximum
02. Over current protection: 1.5A maximum with auto-recovery function
03. Short Circuit: The adapter shall not be damaged by short the DC output to Ground.

C) SAFETY

01. Dielectric Withstand Voltage: Primary To Secondary: 3000VAC 10mA 1minute or 4242VDC 10mA 1minute
02. Leakage Current:20uA maximum, at nominal AC input voltage and frequency

D) EMC

01. Emissions, per EN 55032, EN 61000-6-3, EN 61000-6-4
 - Conducted Emissions: Class B, FCC Part 15, Class B
 - Radiated Emissions: Class B, FCC Part 15, Class B
02. Line Frequency Harmonics EN61000-3-2, Class A
03. Voltage Fluctuations/Flicker EN61000-3-3
04. Immunity, per EN 55024, EN 61000-6-1, EN 61000-6-2
 - Static Discharge Immunity EN61000-4-2, 4kV Contact Discharge, 8kV air discharge
 - Radiated RF Immunity EN61000-4-3, 3V/m 80-1000MHz, 80% 1KHz AM.
 - EFT/Burst Immunity EN61000-4-4, 1kV/100kHz.
 - Line Surge Immunity EN61000-4-5, 1kV differential, 2kV common-mode
 - Conducted RF Immunity EN61000-4-6, 3Vrms, 80% 1KHz AM
 - Power Frequency Magnetic Field Immunity EN61000-4-8, 1A/m
 - Voltage Dip Immunity EN61000-4-11, Criteria

E) OTHER:

01. MTBF: 200,000 Hours @ 25°C ambient temperature
02. Operating Temperature: 0°C to 40°C ambient temperature
03. Humidity: 0% to 90% relative humidity
04. Storage Temperature: -20°C to 60°C
05. Cooling: natural convection cooling
06. ROHS 2: Complies with EU 2011/65/EU and China SJ/T 11363-2006

F) ENCLOSURE

01. Housing: High impact plastic, 94V0 polycarbonate, non-vented
02. Markings: Label and/or Pad Printed and/or Molded in the case

Delivering leading edge, innovative power solutions for more than **30** years....

Model:GT-83083-0505 (F-Blade)

September 19, 2019

DERATING CURVE

**Typical External
Power Supply Derating Curve**
(For Efficiency Level V and Efficiency Level VI Products)

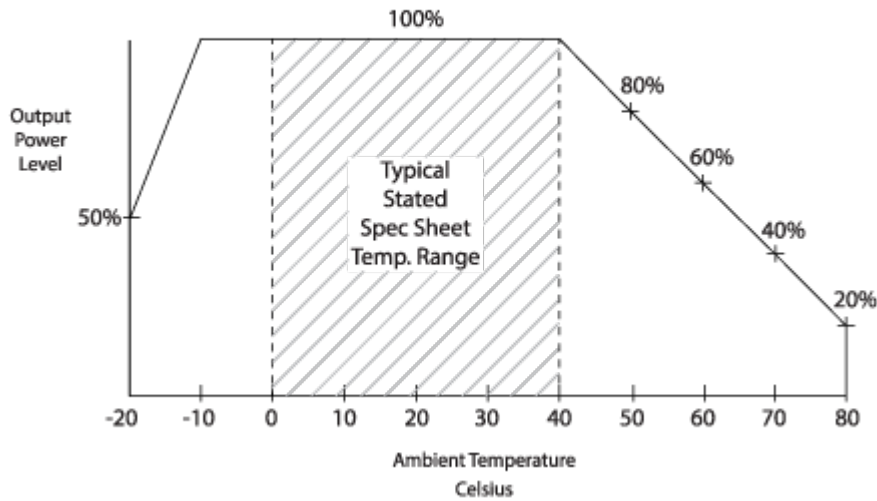

Delivering leading edge, innovative power solutions for more than **30** years....

Model:GT-83083-0505 (F-Blade)

September 19, 2019

Input Configuration

Description Blade Options for F- Series Wall Plug-in Power Supplies



INPUT CONNECTOR: F-Socket

(below are available blades configurations which are "not included" (unless stated above); can be purchased separately, package with power supply or as a separate "F-KIT" if specified

- 01. United States / Canada / Japan NEMA 1-15P configuration: NA 2 blades, Class II; US/CA/JP P/N: F-NA(R)
- 02. European CEE 7/16 configuration: Europlug 2 pins, Class II; EU P/N: F-EU(R)
- 03. UK BS 1363 configuration: UK 3 blade with dummy Ground, Class II; GB P/N: F-UK(R)
- 04. Australian AS 3112 configuration: SAA 2 blade, Class II; AU P/N: F-SAA(R)
- 05. Brazilian NBR6147 configuration: 2 pins, Class II;SIMILAR TO IEC TYPE C BR P/N: F-BR(R)

F-KIT: 1,2,3,4,5 above

Delivering leading edge, innovative power solutions for more than 30 years....

Model:GT-83083-0505 (F-Blade)

September 19, 2019

Output Configuration

Common output connector options:

 L Type (Coaxial
5.5x2.5mm plug)

 C Type (Coaxial
5.5x2.1mm plug)

 K Type (Coaxial
3.5x1.3mm plug)

 LL Type (5.5x2.5mm
Locking 760k type)

 CL Type (5.5x2.1mm
Locking S761k type)

 ML2 Type (Molex
housing 43025-0200)

YL3 Type (KPPX-3P)



YL4 Type (KPPX-4P)

 EJ1/2/3/4/5 (EIAJ
RC-5320A type
connectors)

MSB Type (Micro USB)

 USBC Type (USB Type
C)

 Inquire for custom
design

 For a comprehensive list of options, [click here](#)









Contact GlobTek for your specific requirements or custom solutions.

Delivering leading edge, innovative power solutions for more than 30 years....

Model:GT-83083-0505 (F-Blade)

September 19, 2019

Approvals

Logo	Description
	Attention Mark / Refer to operating manual for operating and service instructions
No Logo Applicable	CB report 60950-1 2nd Ed
	CE Mark: tested to comply with EN55022:2006/A1:2007 Class B, EN610003-2, EN610003-3 including EN61000-4-2, EN61000-4-3, EN61000-4-4, EN61000-4-5, EN61000-4-6N EN61000-4-11; EMI: Complies with EN55011 CLASS B and FCC Part 15B - On label or Molded in case
	CHINA SJ/T 11364-2014, China RoHS Chart: http://en.globtek.com/globtek-rohs.php
	UL60950-1, cULus to UL 60950-1, 2nd Edition, 2007-03-27 and CSA C22.2 No. 60950-1-07, 2nd Edition, 2007-03
	Indoor Use Only - Mark is on the label or Molded in the case
 GlobTek, Inc.	JAPAN TUV R-PSE, Cert. No. JD 50326964, to J60950-1(H26) , J55022(H22).[15V or less]. Please reference the following website for guidelines on PSE regulations: http://en.globtek.com/importing-ite-and-medical-power-supplies-ac-adaptors-to-japan/
EFFICIENCY LEVEL VI	Efficiency: complies to section 301 of Energy Independence and Security Act (EISA) complies with Energy Star tier 2 (North America), ECP tier 2 (China), MEPS tier 2 (Australia), Code of Conduct (Europe)
LPS  IEC/EN60950-1	Limited Power Source SIQ Mark License EN60950-1
	Japan: Voluntary Control Council for Interference (VCCI)
	WEEE: Complies with EU 2012/19/EU (http://ec.europa.eu/environment/waste/weee/index_en.htm) Mark is on the label or Molded in the case