

Delivering leading edge, innovative power solutions for more than **30** years....

Model:GT-46181-18VV-T3

September 19, 2019

DOE EPS 2.0 Level VI 60950 Class II Rated Desktop/Tabletop Power Supply / Charger / AC Adapter, 18W, Available with 5-24VDC output

Information

Model Number GT-46181-18VV-T3

Description GT-46181-18VV-T3, ITE Power Supply, Desktop/External, Regulated Switchmode AC-DC Power Supply AC Adaptor, , Input Rating: 100-240V~, 50-60 Hz, IEC 60320/C14 AC Inlet Connector, Class I, Earth Ground, Output Rating: 18 Watts, Power rating with convection cooling (W) , 5-15V in 0.1V increments, Approvals: 230V CoC Tier 2; EAC; BIS; CCC; FCC; CE; China RoHS; Class I; IP40; Level VI; LPS; PSE; RoHS; Ukraine; VCCI; WEEE; S-Mark 60950; PSE; PSE; CB 60950; CAN ICES-3; RCM; Korea (12V Only); FCC; cULus;

Model Picture



Agency Documents <http://www.globtek.info/certs/GT-46181-18VV-TZ/>
CE https://www.globtek.com/pdf/ec_declaration/a0Oa000000Miro3EAB
EC-Declaration https://www.globtek.com/pdf/rohs_cert/a0Oa000000Miro3EAB
RoHS/RoHS2 Declaration https://www.globtek.com/pdf/iso_certificates/REACH.pdf
REACH Declaration <https://www.globtek.com/pdf/conflict-minerals.pdf>
Conflict Minerals Declaration

Delivering leading edge, innovative power solutions for more than **30** years....

Model:GT-46181-18VV-T3

September 19, 2019

Model Parameters

Type	Desktop/External
Technology	Regulated Switchmode AC-DC Power Supply AC Adaptor
Category	ITE Power Supply
Input Voltage	100-240V~, 50-60 Hz
I/P Amps (A)	0.5A
Wattage (W)	18.0
Vout Range (V)	5-15
Efficiency Level	VI
Ingress Protection	
Size (mm)	50*80.6*31

Delivering leading edge, innovative power solutions for more than **30** years....

Model:GT-46181-18VV-T3

September 19, 2019

ENCLOSURE

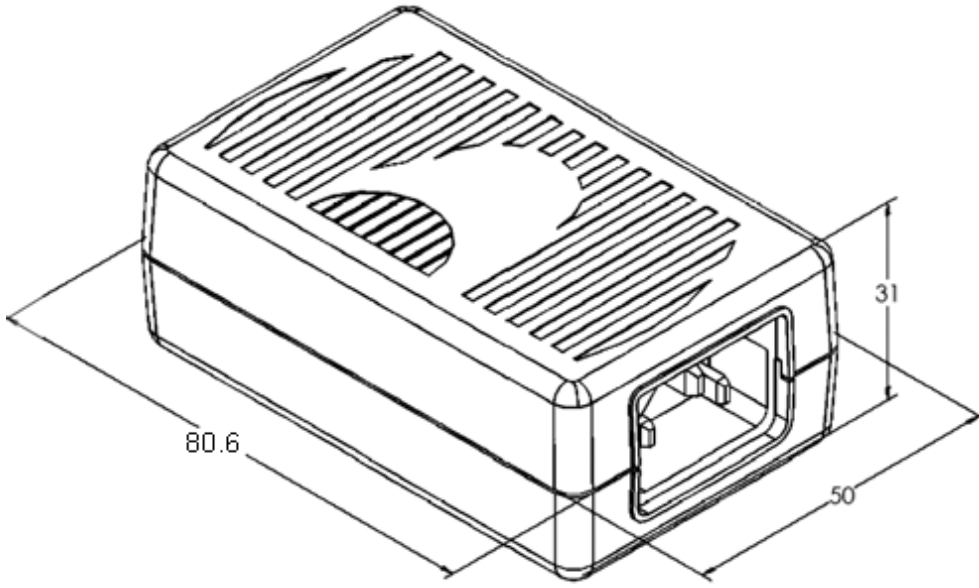

Delivering leading edge, innovative power solutions for more than **30** years....

Model:GT-46181-18VV-T3

September 19, 2019

RATING TABLE

Model Number	Voltage	Amps(A)	Watts(W)	RFQ
GT-46181-1209-3.05-T3	5.95 V	2	11.90	RFQ
GT-46181-1812-4.5-T3	7.5 V	2.4	18.00	RFQ
GT-46181-1809-T3	9 V	2	18.00	RFQ
GT-46181-1812-2.5-T3	9.5 V	1.89	17.96	RFQ
GT-46181-1812-2.0-T3	10 V	1.8	18.00	RFQ
GT-46181-1812-1.0-T3	11 V	1.636	18.00	RFQ
GT-46181-1812-T3	12 V	1.5	18.00	RFQ
GT-46181-1815-2.0-T3	13 V	1.384	17.99	RFQ
GT-46181-1815-1.5-T3	13.5 V	1.333	18.00	RFQ
GT-46181-1815-1.0-T3	14 V	1.285	17.99	RFQ
GT-46181-1815-T3	15 V	1.2	18.00	RFQ

Delivering leading edge, innovative power solutions for more than 30 years....

Model:GT-46181-18VV-T3

September 19, 2019

SPECIFICATIONS**A) ELECTRICAL SPECIFICATIONS:**

01. Input Voltage: Specified 90-264 Vac, Nameplate rated: 100-240Vac
02. Input Frequency: Specified 47-63 Hz, Nameplate rated 50-60Hz
03. Output Regulation: +/- 5% measured at the output connector
Output Regulation +/- 2% is optional (RFP3851)
04. Line Voltage Regulation: +/- 1% typical measured at the output connector
05. Output Ripple (Vp-p): +/-1% or 150 mV whichever is greater, measured at 20 MHz bandwidth with 0.1 uf ceramic capacitor in parallel with 10 uf electrolytic capacitor connected at the end of the output connector at nominal line
06. Average Efficiency: 85% Min (CEC & DOE LEVEL VI Compliant), 85.45% Min (ErP European Commission's Ecodesign Directive (2005/32/EC) / CoC Tier 2 Compliant)
07. Input power(no load): <0.1W (CEC & DOE LEVEL VI Compliant), <0.075W (ErP European Commission's Ecodesign Directive (2005/32/EC) / CoC Tier 2 Compliant)
08. Turn-ON/OFF Overshoot: 5% maximum, 1 mS typical recovery time for 25% to 50% step load
09. Turn-ON Delay: 1 Second, Typical
10. Hold-Up Time: 8 mS typical @ nominal input voltage and full load
11. Inrush Current: 30A Typical at 115VAC input and 60A typical at 230VAC input
12. Switching Frequency: 65 KHz typical

B) PROTECTION

01. Over-Voltage: Electronically Protected Zener clamp across the output
02. Short Circuit: Electronically Protected unit will auto recover upon removal of fault
03. Input Protection: Input line fusing

C) SAFETY

01. Dielectric Withstand Voltage: 4242Vdc from primary to secondary
02. Earth Leakage Current: <3.5 mA at 240Vac input voltage
03. Earth continuity test:<0.1 Ohm or < 0.2 Ohm when with a non-detachable Power Supply cord, Class I Only
04. ROHS 2: Complies with EU 2011/65/EU and China GB/T26572-2011

D) OTHER:

01. MTBF: 200,000 Hours @ 25°C ambient temperature
02. Operating Temperature: 0°C to 40°C ambient temperature
03. Humidity: 0% to 90% relative humidity
04. Storage Temperature: -10°C to 80°C

E) ENCLOSURE

01. Housing: High impact plastic, 94V0 polycarbonate, non-vented
02. Size: 50.0*80.6*31.0 +/-1.0 mm
03. Markings: Label and/or Pad Printed and/or Molded in the case

Delivering leading edge, innovative power solutions for more than **30** years....

Model:GT-46181-18VV-T3

September 19, 2019

DERATING CURVE

**Typical External
Power Supply Derating Curve**

(For Efficiency Level V and Efficiency Level VI Products)

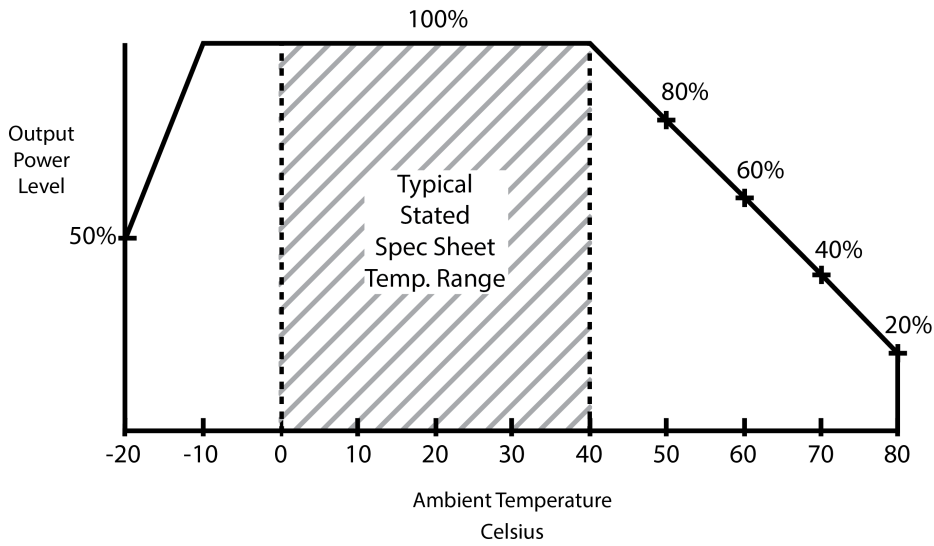

Delivering leading edge, innovative power solutions for more than 30 years....

Model:GT-46181-18VV-T3

September 19, 2019

Input Configuration

Description IEC 60320/C14 AC Inlet Connector, Class I, Earth Ground



Mates with IEC 60320/C13 Plug

Optional Locking IEC60320 Receptacle and cord option available on some models by request.:

[Standard International IEC 320/C13 Cordsets](#)

Below are standard cordsets which are "not included" (unless stated above); these can be purchased separately or packaged with the power supply. Contact your Sales Engineer if the style required is not shown below. Many more available in different lengths, colors or cable material.

Stock Power Supply Cords

Part Number/ Link	Country	Plug	Termination	Length (mm)	(Ft)
3021457F701(R)	N. American (Type B)	NEMA 5-15P	IEC 320/C13	2150	7
1191068F0701(R)	N. American (Type B)	NEMA 5-15P Hospital	IEC 320/C13	2459	8
2194272M5701-T(R)	Argentina (Type I)	IRAM 2073	IEC 320/C13	2500	8
5502022M5701A(R)	Australian (Type I)	AS3112 / 3 PRONG	IEC 320/C13	2500	8
204B4272M5701(R)	Brazil (Type N)	BRAZIL	IEC 320/C13	2500	8
6023602M5701(R)	China (Type I)	CCC GR2099	IEC 320/C13	2500	8
G8014272M5701(R)	Danish (Type K)	AFSNIT SECTION 107-2-D1	IEC 320/C13	2500	8
23144272M5701-T(R)	Europe (Type E)	CEE 7/7	IEC 320/C13	2500	8
205IN4272M5701(R)	India (Type D)	India IS 1293 (also known as IA16A3 or BS546)	IEC 320/C13	2500	8
208IN4272M5701(R)	India (Type M)	India IS 1293 (also known as IA16A3 or BS546)	IEC320/C13	2500	8
377C4272M5701(R)	Israel (Type H)	ISL 377C	IEC 320/C13	2500	8
23024272M5701(R)	Italy (Type L)	CEI 23-16/VII	IEC 320/C13	2500	8
3003339F701(R) [3x1.25mm2]	Japan (Type B)	JIS 8303 / 3 PINS	IEC 320/C13	2500	8

Delivering leading edge, innovative power solutions for more than **30** years....

Model:GT-46181-18VV-T3

September 19, 2019

3003068F2701-HK(R) [3 x 2.0mm2]						
302J115J6F0701J(R)	Japan / North America (Type B – 12A)	JIS 8303 / 3 PINS and NEMA 5-15P (PSE and UL/CUL appr)	IEC 320/C13	1830	6	
302J104J6F0701J(R)	Japan / North America (Type B – 15A)	JIS 8303 / 3 PINS and NEMA 5-15P (PSE and UL/CUL appr)	IEC 320/C13	1830	6	
2313K3432M5701(R)	Korea (Type F)	KS C 8305	IEC 320/C13	2500	8	
5804272M5701(R)	Russia (Type F)	GOST 7396	IEC 320/C13	2500	8	
2084272M5701(R)	South Africa (Type M)	South Africa SABS164-1 (16A type)	IEC 320/C13	2500	8	
23214272M5701(R)	Switzerland (Type J)	SEV 1011	IEC 320/C13	2500	8	
3003322M5701(R)	Taiwan (Type B)	BSMI	IEC 320/C13	2500	8	
PZ0800100-2M5BK13H(R)	UK, Hong Kong, Singapore, Gulf States (Type G)	BS 1363A	IEC 320/C13	2500	8	
7055002M5701A(R)	International	IEC 320 C14-C13	IEC 320/C13	2500	8	

Delivering leading edge, innovative power solutions for more than 30 years....

Model:GT-46181-18VV-T3

September 19, 2019

Output Configuration

Common output connector options:

 L Type (Coaxial
5.5x2.5mm plug)

 C Type (Coaxial
5.5x2.1mm plug)

 K Type (Coaxial
3.5x1.3mm plug)

 LL Type (5.5x2.5mm
Locking 760k type)

 CL Type (5.5x2.1mm
Locking S761k type)

 ML2 Type (Molex
housing 43025-0200)

YL3 Type (KPPX-3P)



YL4 Type (KPPX-4P)

 EJ1/2/3/4/5 (EIAJ
RC-5320A type
connectors)

MSB Type (Micro USB)

 USBC Type (USB Type
C)

 Inquire for custom
design

 For a comprehensive list of options, [click here](#)

Contact GlobTek for your specific requirements or custom solutions.

Delivering leading edge, innovative power solutions for more than 30 years....

Model:GT-46181-18VV-T3

September 19, 2019







Approvals

Logo	Description
No Logo Applicable	EU 230V CoC Tier 2, 278/2009, Mar 2014
	Bureau Of Indian Standards for: GT-46181-0809-3.8-T3,1209-3.05-T3,1505-T3,1605-T3,1805-T3,1809-3.05-T3,1809-T3, 1812-2.0-T3-1812-T3, 1815-T3 GT-46600-6012-T3, 6012-T3A,6015-1.8-T3, 6015-T3, 6015-T3A, 6024-5.0-T3, 6024-6.0-T3, 6024-T3, 6524-5.0, 6524-T3
No Logo	CB Report IEC 60950-1:2005 (Second Edition) + Am 1:2009 + Am 2:2013 (GT-46181 only)
	CCC to GB4943.1-2011 GB9254-2008 GB17625.1-2012
2000	
	CE Mark: tested to comply with EN55022:2006/A1:2007 Class B, EN610003-2, EN610003-3 including EN61000-4-2, EN61000-4-3, EN61000-4-4, EN61000-4-5, EN61000-4-6N EN61000-4-11; EMI: Complies with EN55011 CLASS B and FCC Part 15B - On label or Molded in case
	CHINA SJ/T 11364-2014, China RoHS Chart: http://en.globtek.com/globtek-rohs.php
	UL60950-1, cULus to UL 60950-1, 2nd Edition, 2014-10-14 and CSA C22.2 No. 60950-1-07, 2nd Edition, 2014-10
	Declaration ДC № EAЭC N RU Д-US.KA01.B.10453_19 Custom Union of Russia, Belarus and Kazakhstan http://www.globtek.com/redirect/?loc=gost-certificate-eac-declaration
No Logo	Greenhouse and Energy Minimum Standards (GEMS) for model GT-46181-1812-T3 Registration No APS4067
	Compliance of this power supply with FCC Part 15, Class B has been demonstrated with a standard output load. The FCC law stipulates that system-level testing is required to demonstrate compliance with the FCC emission limits with the actual system load.
CAN ICES-3(B)/NMB-3(B)	Compliance of this PSU with Industry Canada, Class B demonstrated with a standard output load. The ICES law stipulates that system-level testing is required to demonstrate compliance with the ICES-3 emission limits with the actual system load.
	Indoor Use Only - Mark is on the label or Molded in the case
IP40	Ingress Protection: ?IP40 to IEC60529:2001 Protection against granular foreign bodies (with I/P cord)
	JAPAN TUV R-PSE, Cert. No. JD 50314327, to J60950-1(H26) , J55022(H22),J3000(H25)[15V or less]. Please reference the following website for guidelines on PSE regulations: http://en.globtek.com/importing-ite-and-medical-power-supplies-ac-adaptors-to-japan/
GlobTek, Inc.	JAPAN TUV R-PSE, Cert. No. JD 50314327, to J60950-1(H26) , J55022(H22),J3000(H25)[DC15?30V]. Please

Delivering leading edge, innovative power solutions for more than **30** years....

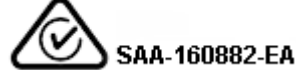
Model:GT-46181-18VV-T3

September 19, 2019

	reference the following website for guidelines on PSE regulations: http://en.globtek.com/importing-ite-and-medical-power-supplies-ac-adaptors-to-japan/
GlobTek, Inc.	
 직류전원장치 AC/DC ADAPTER KTC HU10499-16029A KCC-REM-GSZ-GT-4181-1812-T3 전기용품안전관리법에 의한 표시 최저소비효율기준 만족 제품 모델명:GT-4181-1812 Mfr. Name: GLOBTEK (SUZHOU) CO.,LTD A/S Center:10-6221-6100	Korea KET KC Mark GT-46181-1812-T3 HU10499-16029A (12V, 15V Only)
EFFICIENCY LEVEL VI	Efficiency: complies to section 301 of Energy Independence and Security Act (EISA) complies with Energy Star tier 2 (North America), ECP tier 2 (China), MEPS tier 2 (Australia), Code of Conduct (Europe)
LPS	Limited Power Source
	JAPAN TUV Rheinland-PSE GlobTek Inc to J60950-1(H26) , J55022(H22),J3000(H25).Please follow the procedure listed in the following link for proper import to Japan: http://en.globtek.com/importing-to-japan.php .
GlobTek, Inc.	
	RCM certificate SAA-160882-EA; Australia and New Zealand Regulatory Compliance, Mark (http://rcm.standards.org.au/rcmfaq/rcmfaq.htm
RoHS	Specifications of directive 2011/65/EU Annex VI (ROHS-2) with amendment 2015/863-EU (ROHS-3) http://www.ce-mark.com/Rohs%20final.pdf
	S-Mark Certificate EN 60950-1:2006 + A11:2009 + A1:2010 + A12:2011 +A2:2013 (http://www.intertek.com/marks/s/)
	Ukraine UKRSepr (Document: www.globtek.com/html/iso_certificates/GT_Ukraine.pdf)
	Japan: Voluntary Control Council for Interference (VCCI)
	WEEE: Complies with EU 2012/19/EU (http://ec.europa.eu/environment/waste/weee/index_en.htm) Mark is on the label or Molded in the case