

Delivering leading edge, innovative power solutions for more than 30 years....

Model:GT-46400-40VV-X.X-T2

August 17, 2019

DOE EPS 2.0 Level VI Power Supply / Charger / AC Adapter, 40W Desktop/Tabletop with Class II Input, Available with 12-24VDC output Certified to Medical and ITE Standards

Information

Model Number GT-46400-40VV-X.X-T2

Description GT-46400-40VV-X.X-T2, ITE Power Supply, Desktop/External, Regulated Switchmode AC-DC Power Supply AC Adaptor, , Input Rating: 100-240V~, 50-60 Hz, IEC 60320/C8 AC Inlet connector, Class II, Non-Earth Ground (aka "Figure-8"), Output Rating: 40 Watts, Power rating with convection cooling (W) , 12-24V in 0.1V increments, Approvals: FCC; China RoHS; CE; CAN ICES-3; NOM; EAC; 230V CoC Tier 2; PSE; CB 60950; SGS (GS); cULus; WEEE; VCCI; Ukraine; RoHS; PSE; LPS; Level VI; IP40; Double Insulation;

Model Picture

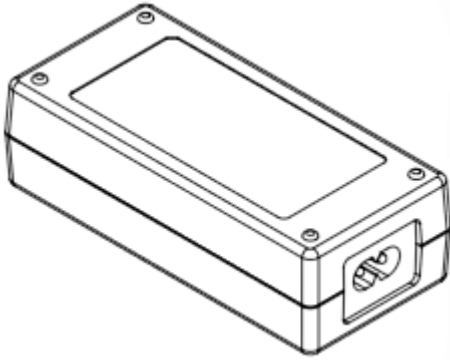

Agency Documents <http://www.globtek.info/certs/GT-46400-WVVV-X.X-TZ/>
CE https://www.globtek.com/pdf/ec_declaration/a0Oa000000Mih2SEAR
EC-Declaration
RoHS/RoHS2 Declaration https://www.globtek.com/pdf/rohs_cert/a0Oa000000Mih2SEAR
REACH Declaration https://www.globtek.com/pdf/iso_certificates/REACH.pdf
Conflict Minerals Declaration <https://www.globtek.com/pdf/conflict-minerals.pdf>

Delivering leading edge, innovative power solutions for more than **30** years....

Model:GT-46400-40VV-X.X-T2

August 17, 2019

Model Parameters

Type	Desktop/External
Technology	Regulated Switchmode AC-DC Power Supply AC Adaptor
Category	ITE Power Supply
Input Voltage	100-240V~, 50-60 Hz
I/P Amps (A)	1.0A
Wattage (W)	40.0
Vout Range (V)	12-24
Efficiency Level	VI
Ingress Protection	Indoor Use
Size (mm)	111*52*32.3

Delivering leading edge, innovative power solutions for more than **30** years....

Model:GT-46400-40VV-X.X-T2

August 17, 2019

ENCLOSURE

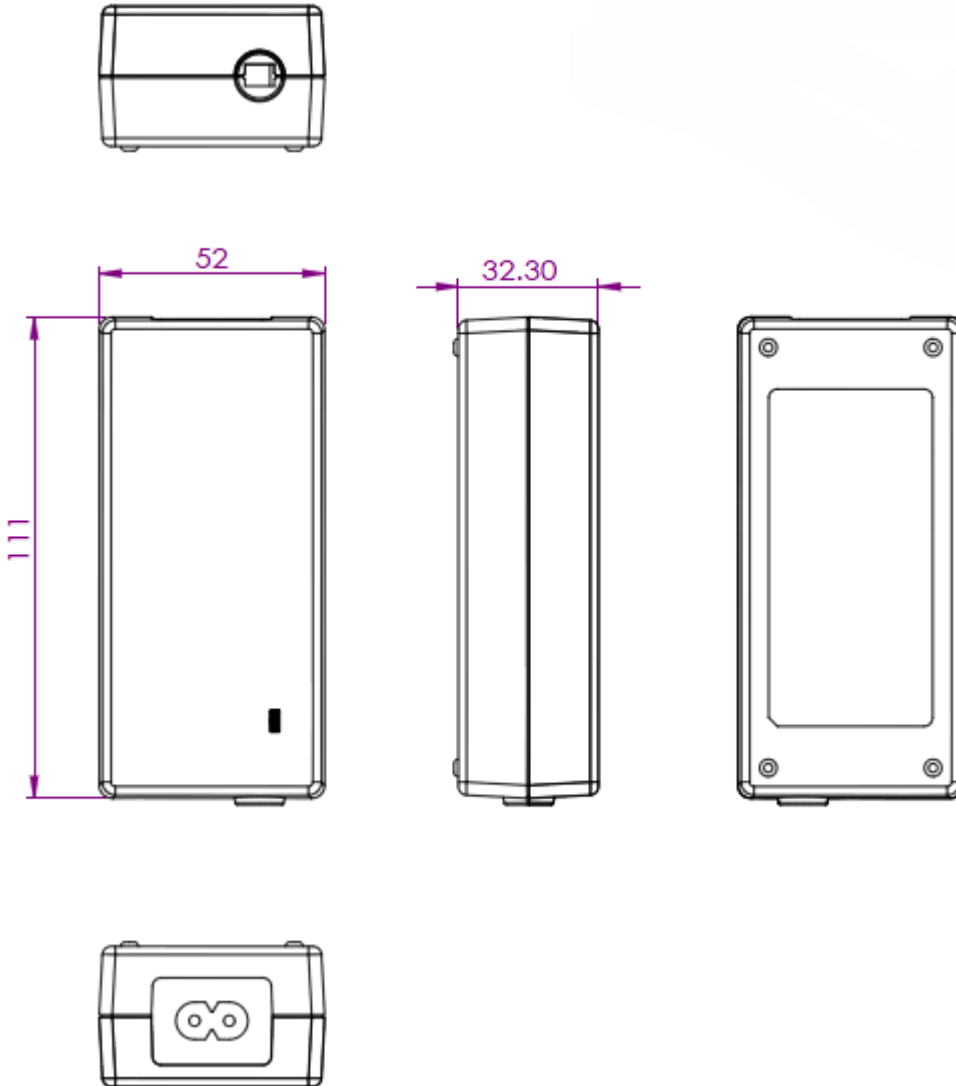

Delivering leading edge, innovative power solutions for more than **30** years....

Model:GT-46400-40VV-X.X-T2

August 17, 2019

RATING TABLE

Model Number	Voltage(V)	Amps(A)	Watts(W)	RFQ
GT-46400-3612-T2	12 V	3	36.00	RFQ
GT-46400-3615-2.0-T213	13 V	2.76	35.88	RFQ
GT-46400-3615-1.0-T214	14 V	2.57	35.98	RFQ
GT-46400-4015-T2	15 V	2.66	39.90	RFQ
GT-46400-4019-3.0-T216	16 V	2.5	40.00	RFQ
GT-46400-4019-2.0-T217	17 V	2.35	39.95	RFQ
GT-46400-4019-1.0-T218	18 V	2.22	39.96	RFQ
GT-46400-4019-T2	19 V	2.1	39.90	RFQ
GT-46400-4024-4.0-T220	20 V	2	40.00	RFQ
GT-46400-4024-3.0-T221	21 V	1.9	39.90	RFQ
GT-46400-4024-2.0-T222	22 V	1.81	39.82	RFQ
GT-46400-4024-1.0-T223	23 V	1.73	39.79	RFQ
GT-46400-4024-T2	24 V	1.66	39.84	RFQ
GT-46400-4048-T2	48 V	0.83	39.84	RFQ

Delivering leading edge, innovative power solutions for more than 30 years....

Model:GT-46400-40VV-X.X-T2

August 17, 2019

SPECIFICATIONS**A) ELECTRICAL SPECIFICATIONS:**

01. Input Voltage: Specified 90-264 Vac, Nameplate rated: 100-240Vac
02. Input Frequency: Specified 47-63 Hz, Nameplate rated 50-60Hz
03. Inrush Current: NO Damage
04. Efficiency: Compliant with Efficiency Level VI and CoC Tier 2 standards
05. No Load Standby Power: <0.075W @ 230Vac
06. Load regulation: $\pm 5\%$
07. Output Voltage: Tolerance $\pm 5\%$
08. Ripple Voltage: 120mV (p-p): Input :(100V-240VAC), Output:full load
Ripple&Noise test: Use 20MHz band width frequency oscilloscope.Add 0.1uF/47uF Capacitor output connector terminal

B) PROTECTION

01. Over voltage protection: $\leq 16V$
02. Short circuit protection: Output shut down and auto- recover
03. Over Load Protection: $\leq 5A$ output load

C) SAFETY

01. HI-POT : Input to output : 3000VAC 10mA 1 minute (for Class II), 1500VAC 10mA 1 minute(for Class I)
02. Insulation resistance: Input to output: 500vdc to test the input to output resistance not be less 100M ohm
03. Touch Current: <0.25mA @ 240Vac input voltage

D) OTHER:

01. MTBF: 200,000 Hours @ 25°C ambient temperature
02. Operating Temperature: 0°C to 40°C ambient temperature
03. Humidity Operating : 20% to 80%. 0% to 90% relative humidity
04. Storage Temperature: -10°C to 70°C
Humidity Storage: 10% to 90%
05. RoHS 2: Complies with EU 2011/65/EU andChina SJ/T 11364-2014

E) ENCLOSURE

01. Housing: High impact plastic, 94V0 polycarbonate, non-vented
02. Size: 111.0 x 52.0 x 32.3 +/-1.0 mm
03. Markings: Label and/or Pad Printed and/or Molded in the case

Delivering leading edge, innovative power solutions for more than 30 years....

Model:GT-46400-40VV-X.X-T2

August 17, 2019

DERATING CURVE

**Typical External
Power Supply Derating Curve**

(For Efficiency Level V and Efficiency Level VI Products)

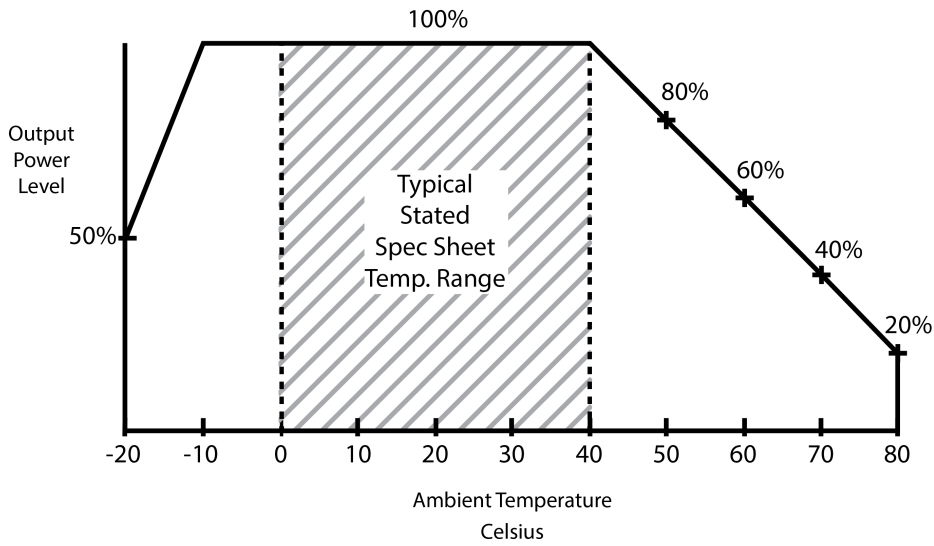

Delivering leading edge, innovative power solutions for more than 30 years....

Model:GT-46400-40VV-X.X-T2

August 17, 2019

Input Configuration

Description IEC 60320/C8 AC Inlet connector, Class II, Non-Earth Ground (aka "Figure-8")

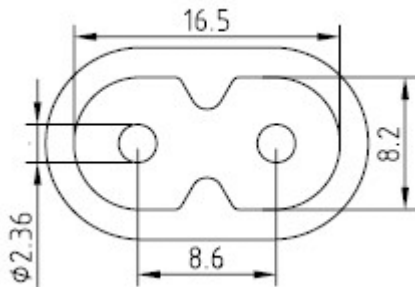

Mates with IEC 60320/C7 Plug

Below are standard cordsets which are "not included" (unless stated above); these may be purchased separately or packaged with the power supply. Please contact your Sales Engineer if the style required is not shown below. Many more available in different lengths, colors or cable material.

Standard International IEC 320/C7 Cordsets

2094112M703(R)	Argentina (Type I)	IRAM 2063	IEC 320/C7	20007
5014112M703A(R)	Australian (Type I)	AS 3112	IEC 320/C7	20007
207B4111M8703(R)	Brazil (Type N)	NBR14136	IEC 320/C7	18006
4533501M8703(R)	China (Type A)	GB 2099.1	IEC 320/C7	18306
2074112M703A(R)	European (Type C)	CEE 7/16	IEC 320/C7	20007
2084111M8703(R)	India (Type M)	BS 546	IEC 320/C7	18006
451J3401M8703(R)	Japan (Type A)	JIS 8303	IEC 320/C7	18306
2044112M703A(R)	Korea (Type C)	KS C8305	IEC 320/C7	20007
4511116F703A(R)	N. American (Type A)	NEMA 1-15P	IEC 320/C7	18306
4033401M8703A(R)	Taiwan (Type A)	CNS690	IEC 320/C7	18306
6104112M703A(R)	UK, Hong Kong, Singapore, Gulf States (Type G)	BS1363	IEC 320/C7	20007

Delivering leading edge, innovative power solutions for more than 30 years....

Model:GT-46400-40VV-X.X-T2

August 17, 2019

Output Configuration

Common output connector options:

 L Type (Coaxial
5.5x2.5mm plug)

 C Type (Coaxial
5.5x2.1mm plug)

 K Type (Coaxial
3.5x1.3mm plug)

 LL Type (5.5x2.5mm
Locking 760k type)

 CL Type (5.5x2.1mm
Locking S761k type)

 ML2 Type (Molex
housing 43025-0200)

YL3 Type (KPPX-3P)



YL4 Type (KPPX-4P)

 EJ1/2/3/4/5 (EIAJ
RC-5320A type
connectors)

MSB Type (Micro USB)

 USBC Type (USB Type
C)

 Inquire for custom
design

 For a comprehensive list of options, [click here](#)











Contact GlobTek for your specific requirements or custom solutions.

Delivering leading edge, innovative power solutions for more than 30 years....

Model:GT-46400-40VV-X.X-T2

August 17, 2019

Approvals

Logo	Description
No Logo Applicable	EU 230V CoC Tier 2, 278/2009, Mar 2014
No Logo	IEC 60950-1: 2005 (Second Edition) + Am 1: 2009 + Am 2: 2013
	CE Mark: tested to comply with EN55022:2006/A1:2007 Class B, EN610003-2, EN610003-3 including EN61000-4-2, EN61000-4-3, EN61000-4-4, EN61000-4-5, EN61000-4-6N EN61000-4-11; EMI: Complies with EN55011 CLASS B and FCC Part 15B - On label or Molded in case
	CHINA SJ/T 11364-2014, China RoHS Chart: http://en.globtek.com/globtek-rohs.php
	UL60950-1, cULus to UL 60950-1 E170507
	Declaration ДС № EAЭC N RU Д-US.KA01.B.10453_19 Custom Union of Russia, Belarus and Kazakhstan http://www.globtek.com/redirect/?loc=gost-certificate-eac-declaration
	Compliance of this power supply with FCC Part 15, Class B has been demonstrated with a standard output load. The FCC law stipulates that system-level testing is required to demonstrate compliance with the FCC emission limits with the actual system load.
CAN ICES-3(B)/NMB-3(B)	Compliance of this PSU with Industry Canada, Class B demonstrated with a standard output load. The ICES law stipulates that system-level testing is required to demonstrate compliance with the ICES-3 emission limits with the actual system load.
	Indoor Use Only - Mark is on the label or Molded in the case
IP40	Ingress Protection: ?IP40 to IEC60529:2001 Protection against granular foreign bodies (with I/P cord)
 GlobTek, Inc.	JAPAN TUV R-PSE, Cert. No. JD 50313285, to J60950-1(H26) , J55022(H22),J3000(H25)[15V or less]. Please reference the following website for guidelines on PSE regulations: http://en.globtek.com/importing-ite-and-medical-power-supplies-ac-adaptors-to-japan/
EFFICIENCY LEVEL 	Efficiency: complies to section 301 of Energy Independence and Security Act (EISA) complies with Energy Star tier 2 (North America), ECP tier 2 (China), MEPS tier 2 (Australia), Code of Conduct (Europe)
LPS  Intertek	Limited Power Source NOM (Mexico) to NOM-001-SCFI-1993 GT-46400-3612-T2
 GlobTek, Inc.	JAPAN TUV Rheinland-PSE GlobTek Inc to J60950-1(H26) , J55022(H22),J3000(H25).Please follow the procedure listed in the following link for proper import to Japan: http://en.globtek.com/importing-to-japan.php .
RoHS	Specifications of directive 2011/65/EU Annex VI (ROHS-2) with amendment 2015/863-EU (ROHS-3) http://www.ce-mark.com/Rohs%20final.pdf

Delivering leading edge, innovative power solutions for more than **30** years....

Model:GT-46400-40VV-X.X-T2

August 17, 2019



SGS GS to EN 60950-1:2006 + A11:2009+A1:2010+A12:2011+A2:2013 AFPS GS 2014:01 PAK



Ukraine UKRSepro (Document: www.globtek.com/html/iso_certificates/GT_Ukraine.pdf)



Japan: Voluntary Control Council for Interference (VCCI)

WEEE: Complies with EU 2012/19/EU (http://ec.europa.eu/environment/waste/weee/index_en.htm)

Mark is on the label or Molded in the case