

Delivering leading edge, innovative power solutions for more than **30** years....

Model:GT-46200-20VV-x.x-T3A

August 17, 2019

GT-46200-20VV-x.x-T3A

Information

Model Number GT-46200-20VV-x.x-T3A
Description Level VI Desktop Power Supply AC Adapter, 20w, output 5-6 VDC

Model Picture



Agency Documents <http://www.globtek.info/certs/GT-46200-20VV-X.X-TZ/>
CE EC-Declaration https://www.globtek.com/pdf/ec_declaration/a0Oa000000MFKj1EAH
RoHS/RoHS2 Declaration https://www.globtek.com/pdf/rohs_cert/a0Oa000000MFKj1EAH
REACH Declaration https://www.globtek.com/pdf/iso_certificates/REACH.pdf
Conflict Minerals Declaration <https://www.globtek.com/pdf/conflict-minerals.pdf>

Delivering leading edge, innovative power solutions for more than **30** years....

Model:GT-46200-20VV-x.x-T3A

August 17, 2019

Model Parameters

Type	Desktop/External
Technology	Regulated Switchmode AC-DC Power Supply AC Adaptor
Category	ITE Power Supply
Input Voltage	100-240V~, 50-60 Hz
I/P Amps (A)	0.5 A
Wattage (W)	20.0
Vout Range (V)	5-6
Efficiency Level	VI
Ingress Protection	Indoor Use
Size (mm)	80.6*50.0*31.0

Delivering leading edge, innovative power solutions for more than **30** years....

Model:GT-46200-20VV-x.x-T3A

August 17, 2019

ENCLOSURE

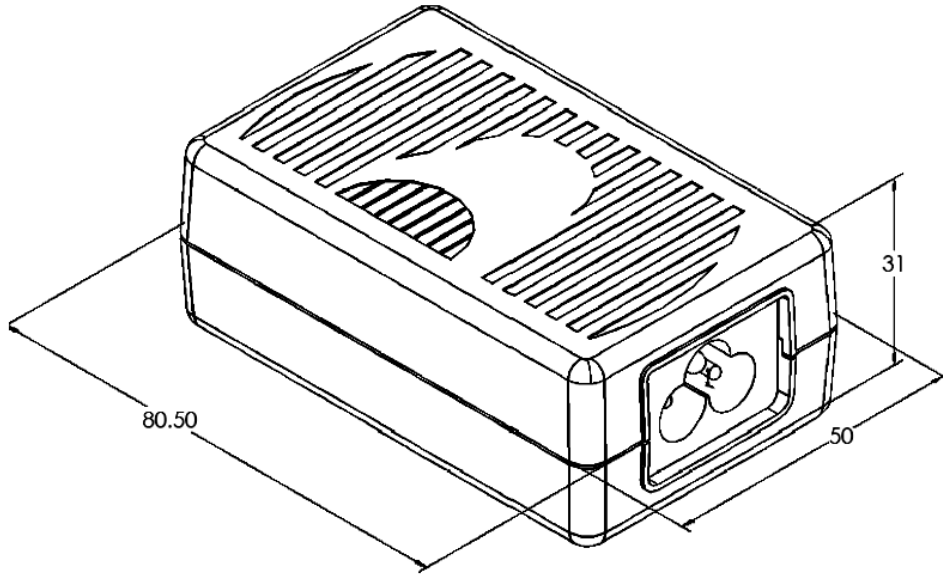

Delivering leading edge, innovative power solutions for more than **30** years....

Model:GT-46200-20VV-x.x-T3A

August 17, 2019

RATING TABLE

Model Number	Voltage	Amps(A)	Watts(W)	RFQ
GT-46200-2005-T3A	5 V	4	20.00	RFQ
GT-46200-1806-0.05-T3A	5.95 V	3	17.85	RFQ

Delivering leading edge, innovative power solutions for more than 30 years....

Model:GT-46200-20VV-x.x-T3A

August 17, 2019

SPECIFICATIONS**A) ELECTRICAL SPECIFICATIONS:**

01. Input Voltage: Specified 90-264 Vac, Nameplate rated: 100-240Vac
 02. Input Frequency: Specified 47-63 Hz, Nameplate rated 50-60Hz
 03. Inrush Current: 50A Max. at 115VAC cold start, 100A Max. at 230VAC cold start
 04. Average Efficiency: 82.44% Min (CEC & DOE LEVEL VI Compliant), 82.97% Min (ErP European Commission's Ecodesign Directive (2005/32/EC) / CoC Tier 2 Compliant)
 05. Input power(no load): <0.1W (CEC & DOE LEVEL VI Compliant), <0.075W (ErP European Commission's Ecodesign Directive (2005/32/EC) / CoC Tier 2 Compliant)
 07. Output Voltage tolerance: $\pm 5\%$
 08. Load regulation: $\pm 5\%$
 09. Output Voltage: Tolerance $\pm 5\%$
 10. Turn On Delay: 3000 mS MAX at 115 VAC Full Load
 11. Hold Up Time: 10 mS Min at 100 VAC Full Load
 12. Ripple Voltage: 150mV (p-p): Input :(100V-240VAC), Output:full load
- Measuring is done by 20MHz bandwidth oscilloscope and terminated each output with a 10uF aluminum electrolytic capacitor and 0.1uF ceramic capacitor.

B) PROTECTION

01. Over voltage protection: protection zener
02. Short circuit protection: Output shut down and auto- recover
03. Over Load Protection: Output shut down and auto restart

C) SAFETY

01. HI-POT : Input to output : 1500VAC or 2121VDC 10mA 1 minute
02. Leakage Current: <0.35mA
03. Earth continuity test:<0.1 Ohm or < 0.2 Ohm when with a non-detachable Power Supply cord, Class I Only
03. Insulation resistance: Input to output: 500vdc to test the input to output resistance not be less 100M ohm

D) EMC

01. Emissions, per EN 55032, EN 61000-6-3, EN 61000-6-4
 - Conducted Emissions: Class B, FCC Part 15, Class B
 - Radiated Emissions: Class B, FCC Part 15, Class B
02. Line Frequency Harmonics EN61000-3-2, Class A
03. Voltage Fluctuations/Flicker EN61000-3-3
04. Immunity, per EN 55024, EN 61000-6-1, EN 61000-6-2
 - Static Discharge Immunity EN61000-4-2, 4kV Contact Discharge, 8kV air discharge
 - Radiated RF Immunity EN61000-4-3, 3V/m 80-1000MHz, 80% 1KHz AM.
 - EFT/Burst Immunity EN61000-4-4, 1kV/100kHz.
 - Line Surge Immunity EN61000-4-5, 1kV differential, 2kV common-mode
 - Conducted RF Immunity EN61000-4-6, 3Vrms, 80% 1KHz AM
 - Power Frequency Magnetic Field Immunity EN61000-4-8, 1A/m
 - Voltage Dip Immunity EN61000-4-11, Criteria

E) OTHER:

01. MTBF: 200,000 Hours @ 25°C ambient temperature
 02. Operating Temperature: 0°C to 40°C ambient temperature
 03. Humidity Operating : 20% to 80%. 0% to 90% relative humidity
 04. Storage Temperature: -10°C to 70°C
- Humidity Storage: 10% to 90%

PROPRIETARY INFORMATION

PROPRIETARY OF GLOBTEK, INC. ANY REPRODUCTION, DISCLOSURE OR USE OF THIS DRAWING, IN WHOLE OR IN PART, IS HEREBY PROHIBITED EXCEPT AS SPECIFIED IN WRITING BY GLOBTEK, INC.

<http://en.globtek.com/datasheet/id/a00a000000MFKj1>

Delivering leading edge, innovative power solutions for more than **30** years....

Model:GT-46200-20VV-x.x-T3A

August 17, 2019

05. RoHS 2: Complies with EU 2011/65/EU and China SJ/T 11364-2014

F) ENCLOSURE

01. Housing: High impact plastic, 94V0 polycarbonate, non-vented

02. Size: 80.6*50.0*31.0 +/-1.0 mm

03. Markings: Label and/or Pad Printed and/or Molded in the case

Delivering leading edge, innovative power solutions for more than 30 years....

Model:GT-46200-20VV-x.x-T3A

August 17, 2019

DERATING CURVE

**Typical External
Power Supply Derating Curve**

(For Efficiency Level V and Efficiency Level VI Products)

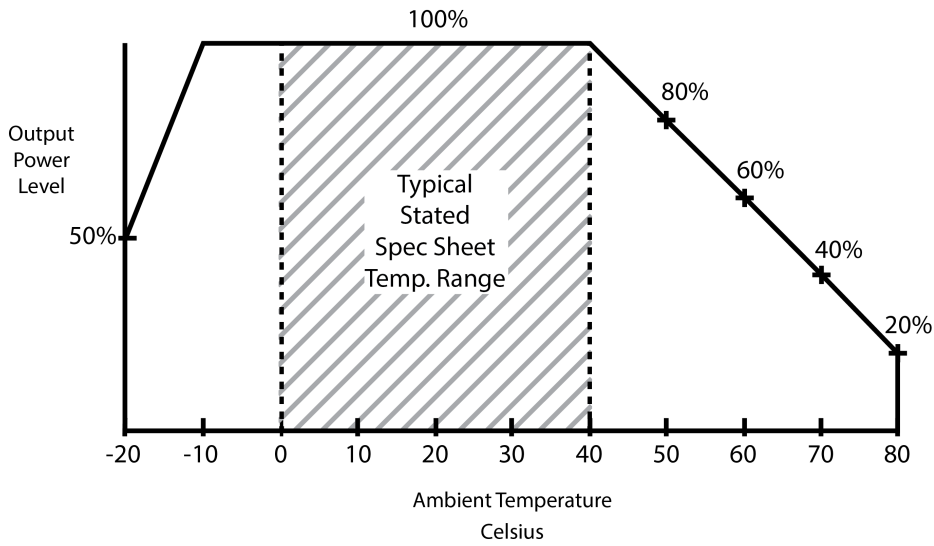

Delivering leading edge, innovative power solutions for more than 30 years....

Model:GT-46200-20VV-x.x-T3A

August 17, 2019

Input Configuration

Description IEC 60320/C6 AC Inlet Connector, Class I, Earth Ground (aka "Mickey Mouse")

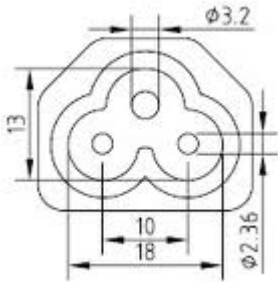

Mates with IEC 60320/C5 Plug

Standard International IEC 320/C5 Cordsets

Below are standard cordsets which are "not included" (unless stated above); these can be purchased separately or package with the power supply. Contact your Sales Engineer if the style required is not shown below. Many more available in different lengths, colors or cable material.

Part Number / Link	Country	Plug	Connector	Length (mm)	Length (ft)
3021066F712(R)	N. American (Type B)	NEMA 5-15P	IEC 320/C5	1880	6
1191068F0712(R)	N. American (Type B)	NEMA 5-15P Hospital	IEC 320/C5	2459	8
2194262M0712(R)	Argentina (Type I)	IRAM 2073	IEC320/C5	2050	6.7
2064262M0712(R)	Australian (Type I)	AS3112 / 3 PRONG	IEC 320/C5	2000	6.6
204B4262M0712(R)	Brazil (Type N)	BRAZIL	IEC 320/C5	2000	6.6
6023592M5712(R)	China (Type I)	CCC GR2099	IEC 320/C5	2500	8
23144262M0712(R)	Europe (Type E)	CEE 7/7	IEC 320/C5	2050	6.6
2313K3432M0712(R)	Korea (Type F)	KS C 8305	IEC 320/C5	2000	6.6
		India IS 1293 (also known			

Delivering leading edge, innovative power solutions for more than **30** years....

Model:GT-46200-20VV-x.x-T3A

August 17, 2019

205IN4262M0712(R)	India (Type D) as IA16A3 or BS546)	IEC320/C5 2000	6.6
377C4262M0712(R)	Israel (Type H) ISL	IEC320/C5 2050	6.7
23024262M0712(R)	Italy (Type L) CEI 23-16/VII	IEC 320/C5 2000	6.6
3003316F0712(R)	Japan (Type B) JIS 8303 / 3 PINS	IEC 320/C5 1830	6
3021066F0712ULPSE(R)	Japan / USA (Type B) JIS 8303 / 3 PINS + NEMA 5-15P	IEC 320/C5 1830	6
2054262M0712(R)	S. Africa (Type D) South Africa SABS164-1 (6A type plug)	IEC320/C5 2050	6.7
2084262M0712(R)	S.Africa (Type M) South Africa SABS164-1 (16A type plug)	IEC 320/C5 2000	6.6
23214262M0712(R)	Switzerland (Type J) SEV 1011 (EL 203)	IEC 320/C5 2000	6.6
3003316F0712(R)	Taiwan (Type B) BSMI	IEC 320/C5 2000	6.6
6104262M0712(R)	UK, Hong Kong, Singapore, Gulf States (Type G) BS1363	IEC 320/C5 2000	6.6

Delivering leading edge, innovative power solutions for more than 30 years....

Model:GT-46200-20VV-x.x-T3A

August 17, 2019

Output Configuration

Common output connector options:

 L Type (Coaxial
5.5x2.5mm plug)

 C Type (Coaxial
5.5x2.1mm plug)

 K Type (Coaxial
3.5x1.3mm plug)

 LL Type (5.5x2.5mm
Locking 760k type)

 CL Type (5.5x2.1mm
Locking S761k type)

 ML2 Type (Molex
housing 43025-0200)

YL3 Type (KPPX-3P)



YL4 Type (KPPX-4P)

 EJ1/2/3/4/5 (EIAJ
RC-5320A type
connectors)

MSB Type (Micro USB)

 USBC Type (USB Type
C)

 Inquire for custom
design

 For a comprehensive list of options, [click here](#)









Contact GlobTek for your specific requirements or custom solutions.

Delivering leading edge, innovative power solutions for more than 30 years....

Model:GT-46200-20VV-x.x-T3A

August 17, 2019

Approvals

Logo	Description
No Logo Applicable	EU 230V CoC Tier 2, 278/2009, Mar 2014
	CCC to GB4943.1-2011; GB/T9254-2008 GB17625.1-2012, Tropical <2000
	CE Mark: tested to comply with EN55022:2006/A1:2007 Class B, EN610003-2, EN610003-3 including EN61000-4-2, EN61000-4-3, EN61000-4-4, EN61000-4-5, EN61000-4-6N EN61000-4-11; EMI: Complies with EN55011 CLASS B and FCC Part 15B - On label or Molded in case
	CHINA SJ/T 11364-2014, China RoHS Chart: http://en.globtek.com/globtek-rohs.php
	UL 60950-1, 2nd Edition, 2014-10-14 (Information Technology Equipment - Safety - Part 1: eneral Requirements) CAN/CSA C22.2 No. 60950-1-07, 2nd Edition, 2014-10 (Information Technology Equipment - Safety - Part 1: General Requirements)
	Declaration ДС № EAЭC N RU Д-US.KA01.B.10453_19 Custom Union of Russia, Belarus and Kazakhstan http://www.globtek.com/redirect/?loc=gost-certificate-eac-declaration
	GOST-R mark for Russia(Document: http://www.globtek.com/html/iso_certificates/GT_GOST-R.pdf). 03/15/2015. Due to lack of demand, GlobTek will not be renewing it's GOST certification. Please contact your sales engineer for pricing on EAC.
	Indoor Use Only - Mark is on the label or Molded in the case
IP40	Ingress Protection: ?IP40 to IEC60529:2001 Protection against granular foreign bodies (with I/P cord)
	JAPAN TUV R-PSE, Cert. No. JD 50314327, to J60950-1(H26) , J55022(H22),J3000(H25)[15V or less]. Please reference the following website for guidelines on PSE regulations: http://en.globtek.com/importing-ite-and-medical-power-supplies-ac-adaptors-to-japan/
GlobTek, Inc. EFFICIENCY LEVEL 	Efficiency: complies to section 301 of Energy Independence and Security Act (EISA) complies with Energy Star tier 2 (North America), ECP tier 2 (China), MEPS tier 2 (Australia), Code of Conduct (Europe)
LPS	Limited Power Source
 N136 SAA-160906-EA	RCM certificate SAA-160906-EA; Australia and New Zealand Regulatory Compliance, Mark (http://rcm.standards.org.au/rcmfaq/rcmfaq.htm)
RoHS	Specifications of directive 2011/65/EU Annex VI (ROHS-2) with amendment 2015/863-EU (ROHS-3) http://www.ce-mark.com/Rohs%20final.pdf
 10276	Ukraine UKRSepr (Document: www.globtek.com/html/iso_certificates/GT_Ukraine.pdf)
	Japan: Voluntary Control Council for Interference (VCCI)
	WEEE: Complies with EU 2012/19/EU (http://ec.europa.eu/environment/waste/weee/index_en.htm) Mark is on the label or Molded in the case