

Delivering leading edge, innovative power solutions for more than **30** years....

Model:GT-46200-20VV-x.x-T3

September 19, 2019

Level VI Desktop Power Supply AC Adapter, 20w, output 5-6 VDC

Information

Model Number GT-46200-20VV-x.x-T3

Description GT-46200-20VV-x.x-T3, ITE Power Supply, Desktop/External, Regulated Switchmode AC-DC Power Supply AC Adaptor, , Input Rating: 100-240V~, 50-60 Hz, IEC 60320/C14 AC Inlet Connector, Class I, Earth Ground, Output Rating: 20 Watts, Power rating with convection cooling (W) , 5-6V in 0.1V increments, Approvals: 230V CoC Tier 2; EAC; SGS (GS); CE; China RoHS; IP40; Level VI; LPS; PSE; RoHS; Ukraine; VCCI; WEEE; Class I; CCC; PSE; cULus; RCM; India;

Model Picture



Agency

Documents <http://www.globtek.info/certs/GT-46200-20VV-X.X-TZ/>

CE

EC-Declaration https://www.globtek.com/pdf/ec_declaration/a0Oa000000MF138EAH

RoHS/RoHS2

Declaration https://www.globtek.com/pdf/rohs_cert/a0Oa000000MF138EAH

REACH

Declaration https://www.globtek.com/pdf/iso_certificates/REACH.pdf

Conflict

Minerals <https://www.globtek.com/pdf/conflict-minerals.pdf>

Declaration

Delivering leading edge, innovative power solutions for more than **30** years....

Model:GT-46200-20VV-x.x-T3

September 19, 2019

Model Parameters

Type	Desktop/External
Technology	Regulated Switchmode AC-DC Power Supply AC Adaptor
Category	ITE Power Supply
Input Voltage	100-240V~, 50-60 Hz
I/P Amps (A)	0.5 A
Wattage (W)	20.0
Vout Range (V)	5-6
Efficiency Level	VI
Ingress Protection	Indoor Use
Size (mm)	80.6*50.0*31.0

Delivering leading edge, innovative power solutions for more than **30** years....

Model:GT-46200-20VV-x.x-T3

September 19, 2019

ENCLOSURE

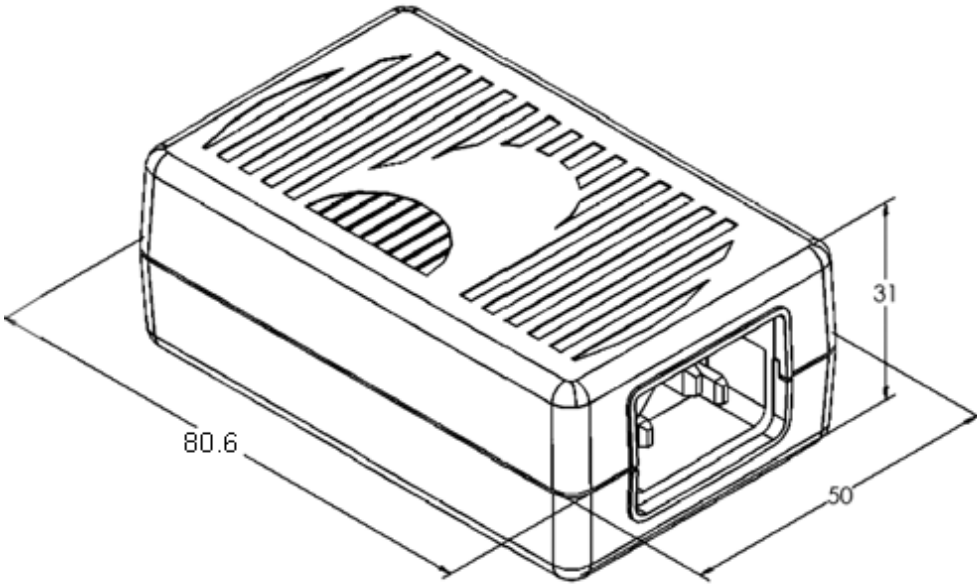

Delivering leading edge, innovative power solutions for more than **30** years....

Model:GT-46200-20VV-x.x-T3

September 19, 2019

RATING TABLE

Model Number	Voltage	Amps(A)	Watts(W)	RFQ
GT-46200-1505-T3	5 V	3	15.00	RFQ
GT-46200-2005-T3	5 V	4	20.00	RFQ
GT-46200-1806-0.05-T3	5.95 V	3	17.85	RFQ

SPECIFICATIONS

A) ELECTRICAL SPECIFICATIONS:

01. Input Voltage: Specified 90-264 Vac, Nameplate rated: 100-240Vac
 02. Input Frequency: Specified 47-63 Hz, Nameplate rated 50-60Hz
 03. Inrush Current: 50A Max. at 115VAC cold start, 100A Max. at 230VAC cold start
 04. Average Efficiency: 82.44% Min (CEC & DOE LEVEL VI Compliant), 82.97% Min (ErP European Commission's Ecodesign Directive (2005/32/EC) / CoC Tier 2 Compliant)
 05. Input power(no load): <0.1W (CEC & DOE LEVEL VI Compliant), <0.075W (ErP European Commission's Ecodesign Directive (2005/32/EC) / CoC Tier 2 Compliant)
 07. Output Voltage tolerance: $\pm 5\%$
 08. Load regulation: $\pm 5\%$
 09. Output Voltage: Tolerance $\pm 5\%$
 10. Turn On Delay: 3000 mS MAX at 115 VAC Full Load
 11. Hold Up Time: 10 mS Min at 100 VAC Full Load
 12. Ripple Voltage: 150mV (p-p): Input :(100V-240VAC), Output:full load
- Measuring is done by 20MHz bandwidth oscilloscope and terminated each output with a 10uF aluminum electrolytic capacitor and 0.1uF ceramic capacitor.

B) PROTECTION

01. Over voltage protection: protection zener
02. Short circuit protection: Output shut down and auto- recover
03. Over Load Protection: Output shut down and auto restart

C) SAFETY

01. HI-POT : Input to output : 1500VAC or 2121VDC 10mA 1 minute
02. Leakage Current: <0.35mA
03. Earth continuity test:<0.1 Ohm or < 0.2 Ohm when with a non-detachable Power Supply cord, Class I Only
03. Insulation resistance: Input to output: 500vdc to test the input to output resistance not be less 100M ohm

D) EMC

01. Emissions, per EN 55032, EN 61000-6-3, EN 61000-6-4
 - Conducted Emissions: Class B, FCC Part 15, Class B
 - Radiated Emissions: Class B, FCC Part 15, Class B
02. Line Frequency Harmonics EN61000-3-2, Class A
03. Voltage Fluctuations/Flicker EN61000-3-3
04. Immunity, per EN 55024, EN 61000-6-1, EN 61000-6-2
 - Static Discharge Immunity EN61000-4-2, 4kV Contact Discharge, 8kV air discharge
 - Radiated RF Immunity EN61000-4-3, 3V/m 80-1000MHz, 80% 1KHz AM.
 - EFT/Burst Immunity EN61000-4-4, 1kV/100kHz.
 - Line Surge Immunity EN61000-4-5, 1kV differential, 2kV common-mode
 - Conducted RF Immunity EN61000-4-6, 3Vrms, 80% 1KHz AM
 - Power Frequency Magnetic Field Immunity EN61000-4-8, 1A/m
 - Voltage Dip Immunity EN61000-4-11, Criteria

E) OTHER:

01. MTBF: 200,000 Hours @ 25°C ambient temperature
 02. Operating Temperature: 0°C to 40°C ambient temperature
 03. Humidity Operating : 20% to 80%. 0% to 90% relative humidity
 04. Storage Temperature: -10°C to 70°C
- Humidity Storage: 10% to 90%

Delivering leading edge, innovative power solutions for more than **30** years....

Model:GT-46200-20VV-x.x-T3

September 19, 2019

05. RoHS 2: Complies with EU 2011/65/EU and China SJ/T 11364-2014

F) ENCLOSURE

01. Housing: High impact plastic, 94V0 polycarbonate, non-vented

02. Size: 80.6*50.0*31.0 +/-1.0 mm

03. Markings: Label and/or Pad Printed and/or Molded in the case

Delivering leading edge, innovative power solutions for more than 30 years....

Model:GT-46200-20VV-x.x-T3

September 19, 2019

DERATING CURVE

**Typical External
Power Supply Derating Curve**

(For Efficiency Level V and Efficiency Level VI Products)

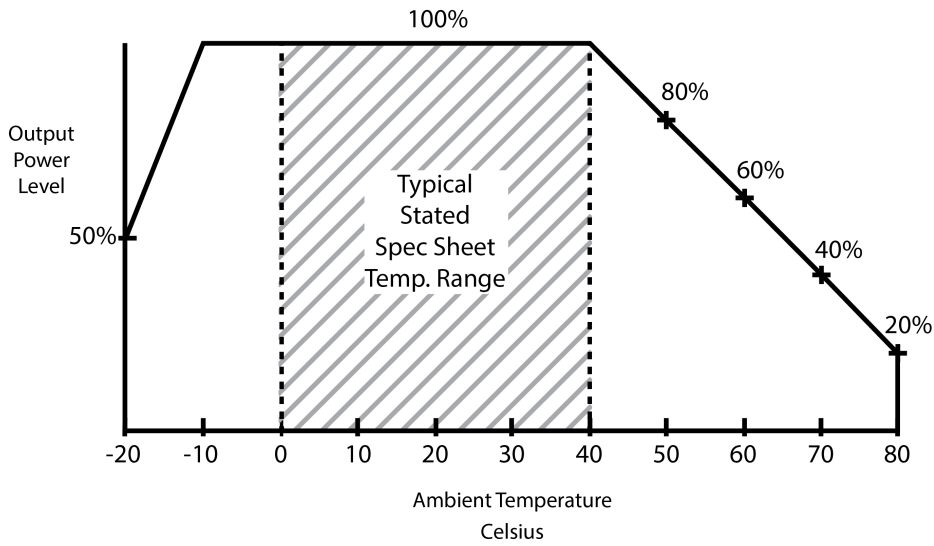

Delivering leading edge, innovative power solutions for more than 30 years....

Model:GT-46200-20VV-x.x-T3

September 19, 2019

Input Configuration

Description IEC 60320/C14 AC Inlet Connector, Class I, Earth Ground



Mates with IEC 60320/C13 Plug

Optional Locking IEC60320 Receptacle and cord option available on some models by request.:



[Standard International IEC 320/C13 Cordsets](#)

Below are standard cordsets which are "not included" (unless stated above); these can be purchased separately or packaged with the power supply. Contact your Sales Engineer if the style required is not shown below. Many more available in different lengths, colors or cable material.

Stock Power Supply Cords

Part Number/ Link	Country	Plug	Termination	Length (mm)	(Ft)
3021457F701(R)	N. American (Type B)	NEMA 5-15P	IEC 320/C13	2150	7
1191068F0701(R)	N. American (Type B)	NEMA 5-15P Hospital	IEC 320/C13	2459	8
2194272M5701-T(R)	Argentina (Type I)	IRAM 2073	IEC 320/C13	2500	8
5502022M5701A(R)	Australian (Type I)	AS3112 / 3 PRONG	IEC 320/C13	2500	8
204B4272M5701(R)	Brazil (Type N)	BRAZIL	IEC 320/C13	2500	8
6023602M5701(R)	China (Type I)	CCC GR2099	IEC 320/C13	2500	8
G8014272M5701(R)	Danish (Type K)	AFSNIT SECTION 107-2-D1	IEC 320/C13	2500	8
23144272M5701-T(R)	Europe (Type E)	CEE 7/7	IEC 320/C13	2500	8
205IN4272M5701(R)	India (Type D)	India IS 1293 (also known as IA16A3 or BS546)	IEC 320/C13	2500	8
208IN4272M5701(R)	India (Type M)	India IS 1293 (also known as IA16A3 or BS546)	IEC320/C13	2500	8
377C4272M5701(R)	Israel (Type H)	ISL 377C	IEC 320/C13	2500	8
23024272M5701(R)	Italy (Type L)	CEI 23-16/VII	IEC 320/C13	2500	8
3003339F701(R) [3x1.25mm2]	Japan (Type B)	JIS 8303 / 3 PINS	IEC 320/C13	2500	8

Delivering leading edge, innovative power solutions for more than **30** years....

Model:GT-46200-20VV-x.x-T3

September 19, 2019

3003068F2701-HK(R) [3 x 2.0mm2]						
302J115J6F0701J(R)	Japan / North America (Type B – 12A)	JIS 8303 / 3 PINS and NEMA 5-15P (PSE and UL/CUL appr)	IEC 320/C13	1830	6	
302J104J6F0701J(R)	Japan / North America (Type B – 15A)	JIS 8303 / 3 PINS and NEMA 5-15P (PSE and UL/CUL appr)	IEC 320/C13	1830	6	
2313K3432M5701(R)	Korea (Type F)	KS C 8305	IEC 320/C13	2500	8	
5804272M5701(R)	Russia (Type F)	GOST 7396	IEC 320/C13	2500	8	
2084272M5701(R)	South Africa (Type M)	South Africa SABS164-1 (16A type)	IEC 320/C13	2500	8	
23214272M5701(R)	Switzerland (Type J)	SEV 1011	IEC 320/C13	2500	8	
3003322M5701(R)	Taiwan (Type B)	BSMI	IEC 320/C13	2500	8	
PZ0800100-2M5BK13H(R)	UK, Hong Kong, Singapore, Gulf States (Type G)	BS 1363A	IEC 320/C13	2500	8	
7055002M5701A(R)	International	IEC 320 C14-C13	IEC 320/C13	2500	8	

Delivering leading edge, innovative power solutions for more than 30 years....

Model:GT-46200-20VV-x.x-T3

September 19, 2019

Output Configuration

Common output connector options:

 L Type (Coaxial
5.5x2.5mm plug)

 C Type (Coaxial
5.5x2.1mm plug)

 K Type (Coaxial
3.5x1.3mm plug)

 LL Type (5.5x2.5mm
Locking 760k type)

 CL Type (5.5x2.1mm
Locking S761k type)

 ML2 Type (Molex
housing 43025-0200)

YL3 Type (KPPX-3P)



YL4 Type (KPPX-4P)

 EJ1/2/3/4/5 (EIAJ
RC-5320A type
connectors)

MSB Type (Micro USB)

 USBC Type (USB Type
C)

 Inquire for custom
design

 For a comprehensive list of options, [click here](#)











Contact GlobTek for your specific requirements or custom solutions.

Delivering leading edge, innovative power solutions for more than 30 years....

Model:GT-46200-20VV-x.x-T3

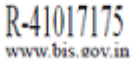
September 19, 2019

Approvals

Logo	Description
No Logo Applicable	EU 230V CoC Tier 2, 278/2009, Mar 2014
	CCC to GB4943.1-2011; GB/T9254-2008 GB17625.1-2012, Tropical <2000
	CE Mark: tested to comply with EN55022:2006/A1:2007 Class B, EN610003-2, EN610003-3 including EN61000-4-2, EN61000-4-3, EN61000-4-4, EN61000-4-5, EN61000-4-6N EN61000-4-11; EMI: Complies with EN55011 CLASS B and FCC Part 15B - On label or Molded in case
	CHINA SJ/T 11364-2014, China RoHS Chart: http://en.globtek.com/globtek-rohs.php
	UL 60950-1, 2nd Edition, 2014-10-14 (Information Technology Equipment - Safety - Part 1: eneral Requirements) CAN/CSA C22.2 No. 60950-1-07, 2nd Edition, 2014-10 (Information Technology Equipment - Safety - Part 1: General Requirements)
	Declaration ДС № EAЭC N RU Д-US.KA01.B.10453_19 Custom Union of Russia, Belarus and Kazakhstan http://www.globtek.com/redirect/?loc=gost-certificate-eac-declaration
	Bureau Of Indian Standards for GT-46200-2005-T3
	
	Indoor Use Only - Mark is on the label or Molded in the case
IP40	Ingress Protection: ?IP40 to IEC60529:2001 Protection against granular foreign bodies
	JAPAN TUV R-PSE, Cert. No. JD 50314327, to J60950-1(H26) , J55022(H22),J3000(H25)[15V or less]. Please reference the following website for guidelines on PSE regulations: http://en.globtek.com/importing-ite-and-medical-power-supplies-ac-adaptors-to-japan/
GlobTek, Inc.	
EFFICIENCY LEVEL VI	Efficiency: complies to section 301 of Energy Independence and Security Act (EISA) complies with Energy Star tier 2 (North America), ECP tier 2 (China), MEPS tier 2 (Australia), Code of Conduct (Europe)
LPS	Limited Power Source
	JAPAN TUV Rheinland-PSE GlobTek Inc to J60950-1(H26) , J55022(H22),J3000(H25).Please follow the procedure listed in the following link for proper import to Japan: http://en.globtek.com/importing-to-japan.php .
GlobTek, Inc.	
	RCM certificate SAA-160906-EA; Australia and New Zealand Regulatory Compliance, Mark (
SAA-160906-EA	http://rcm.standards.org.au/rcmfaq/rcmfaq.htm
RoHS	Specifications of directive 2011/65/EU Annex VI (ROHS-2) with amendment 2015/863-EU (ROHS-3) http://www.ce-mark.com/Rohs%20final.pdf

Delivering leading edge, innovative power solutions for more than **30** years....

Model:GT-46200-20VV-x.x-T3

September 19, 2019



SGS GS to EN 60950-1:2006 + A11+A1+A12+A2 AFPS GS 2014:01 PAK



Ukraine UKRSepr (Document: www.globtek.com/html/iso_certificates/GT_Ukraine.pdf)



Japan: Voluntary Control Council for Interference (VCCI)

WEEE: Complies with EU 2012/19/EU (http://ec.europa.eu/environment/waste/weee/index_en.htm)
Mark is on the label or Molded in the case