

Delivering leading edge, innovative power solutions for more than **30** years....

Model:GT-83082-3612-W2

August 18, 2019

## GT-83082-3612-W2

### Information

Model Number GT-83082-3612-W2

Description GT-83082-3612-W2, ITE Power Supply, Wall Plug-in, Regulated Switchmode AC-DC; Current Limited Power Supply AC Adaptor, , Input Rating: 100-240V , 50/60Hz, NEMA 1-15P, North America Blades, Class II 2 Conductors, Output Rating: 36 Watts, Power rating with convection cooling (W) , 12V in 0.1V increments, Approvals: CB 60950; CE; cULus; Double Insulation; Level VI; LPS; PSE; RoHS; VCCI; WEEE;

Model Picture



Agency Documents <http://www.globtek.info/certs/GT-83082-W2Z/>  
CE [https://www.globtek.com/pdf/ec\\_declaration/a0Oa000000MEww5EAD](https://www.globtek.com/pdf/ec_declaration/a0Oa000000MEww5EAD)  
EC-Declaration  
RoHS/RoHS2 Declaration [https://www.globtek.com/pdf/rohs\\_cert/a0Oa000000MEww5EAD](https://www.globtek.com/pdf/rohs_cert/a0Oa000000MEww5EAD)  
REACH Declaration [https://www.globtek.com/pdf/iso\\_certificates/REACH.pdf](https://www.globtek.com/pdf/iso_certificates/REACH.pdf)  
Conflict Minerals Declaration <https://www.globtek.com/pdf/conflict-minerals.pdf>

Delivering leading edge, innovative power solutions for more than **30** years....

Model:GT-83082-3612-W2

August 18, 2019

**Model Parameters**

Type	Wall Plug-in
Technology	Regulated Switchmode AC-DC; Current Limited Power Supply AC Adaptor
Category	ITE Power Supply
Input Voltage	100-240V~, 50/60Hz
I/P Amps (A)	1.0A
Wattage (W)	36.0
Vout Range (V)	12
Efficiency Level	VI
Ingress Protection	
Size (mm)	93*33*78.69+/-0.5

Delivering leading edge, innovative power solutions for more than **30** years....

Model:GT-83082-3612-W2

August 18, 2019

ENCLOSURE

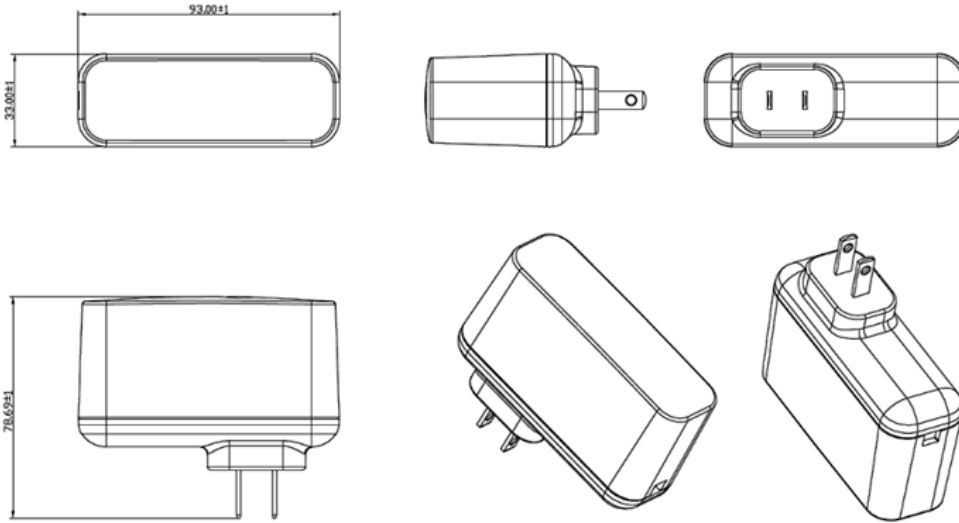

Delivering leading edge, innovative power solutions for more than **30** years....

Model:GT-83082-3612-W2

August 18, 2019

**RATING TABLE**

Model Number	Voltage	Amps(A)	Watts(W)	RFQ
GT-83082-3612-W2	12 V	3	36.00	<a href="#">RFQ</a>
GT-83082-3648-W2	48 V	0.75	36.00	<a href="#">RFQ</a>

Model:GT-83082-3612-W2

August 18, 2019

**SPECIFICATIONS**

01. Input Voltage: Specified 90-264 Vac, Nameplate rated: 100-240Vac
02. Input Frequency: Specified 47-63 Hz, Nameplate rated 50-60Hz
03. The adapter input/output are full range AC input and +12V DC with 36 watts maximum output.
04. NOMINAL AC INPUT VOLTAGE 1 A maximum, No damage shall be occurred and the input fuse shall not be blown up.
05. POWER CONSUMPTION: 115VAC/230VAC INPUT , power consumption less than 0.1W
- 06.200 mVp-p maximum Ripple and Noise:At 20 MHz, and output parallel with 0.1uF & 47uF capacitors to ground. Temperature at 25°C, and nominal input voltage (Optional 120 mVp-p maximum Ripple)
07. Turn-ON Delay: 3 Seconds maximum at nominal input voltage
08. Inrush Current: at full load, 25°C, cold start
09. RISE TIME: 100mS maximum at nominal input voltage
- 10.Efficiency: Compliant with Efficiency Level VI and CoC Tier 2 standards
11. No Load Standby Power: <0.075W @ 230Vac
12. Capacitance load ability(CR mode): 12V,Output set CR mode,and 4000uF capacitor @115Vac/60Hz and 230Vac/50Hz ; 0% and 100% load
13. OUTPUT REGULATION +/-5%

**B) PROTECTION**

01. Over-current protection
02. Over-voltage protection
03. Short-circuit protection:Short circuit protection is to be included in the construction of the adaptor. The adaptor is designed to withstand continuous current of a short circuit on the output. The adaptor will be short circuit tolerant for an indefinite period.

**C) SAFETY**

01. Dielectric Withstand Voltage: Primary To Secondary: 3000VAC 10mA 1minute or 4242VDC 10mA 1minute
02. 0.25mA maximum, at nominal AC input voltage and frequency
03. Touch Current: <0.25mA @ 240Vac input voltage

**D) EMC**

01. Emissions, per EN 55032, EN 61000-6-3, EN 61000-6-4  
Conducted Emissions: Class B, FCC Part 15, Class B  
Radiated Emissions: Class B, FCC Part 15, Class B
02. Line Frequency Harmonics EN61000-3-2, Class A
03. Voltage Fluctuations/Flicker EN61000-3-3
04. Immunity, per EN 55024, EN 61000-6-1, EN 61000-6-2  
Static Discharge Immunity EN61000-4-2, 4kV Contact Discharge, 8kV air discharge  
Radiated RF Immunity EN61000-4-3, 3V/m 80-1000MHz, 80% 1KHz AM.  
EFT/Burst Immunity EN61000-4-4, 1kV/100kHz.  
Line Surge Immunity EN61000-4-5, 1kV differential, 2kV common-mode  
Conducted RF Immunity EN61000-4-6, 3Vrms, 80% 1KHz AM  
Power Frequency Magnetic Field Immunity EN61000-4-8, 1A/m  
Voltage Dip Immunity EN61000-4-11, Criteria

**E) OTHER:**

01. MTBF: 200,000 Hours @ 25°C ambient temperature
02. Operating Temperature: -5 °C TO 45 °C
03. Operating Humidity: 20 ~ 85 % RH. non-condensing

**PROPRIETARY INFORMATION**

PROPRIETARY OF GLOBTEK, INC. ANY REPRODUCTION, DISCLOSURE OR USE OF THIS DRAWING, IN WHOLE OR IN PART, IS HEREBY PROHIBITED EXCEPT AS SPECIFIED IN WRITING BY GLOBTEK, INC.

<http://en.globtek.com/datasheet/id/a00a000000MEww5>

Delivering leading edge, innovative power solutions for more than **30** years....

Model:GT-83082-3612-W2

August 18, 2019

- 05. Storage Temperature: -20 °C TO +80 °C
- 06. Storage Humidity:5 ~ 95 % RH. non-condensing
- 07. Cooling: Cooling shall be with natural convection cooling
- 08. RoHS 2: Complies with EU 2011/65/EU China SJ/T 11364-2014

## F) ENCLOSURE

- 01. Housing: High impact plastic, 94V0 polycarbonate, non-vented
- 02. Markings: Label and/or Pad Printed and/or Molded in the case

Delivering leading edge, innovative power solutions for more than 30 years....

Model:GT-83082-3612-W2

August 18, 2019

DERATING CURVE

**Typical External  
Power Supply Derating Curve**

(For Efficiency Level V and Efficiency Level VI Products)

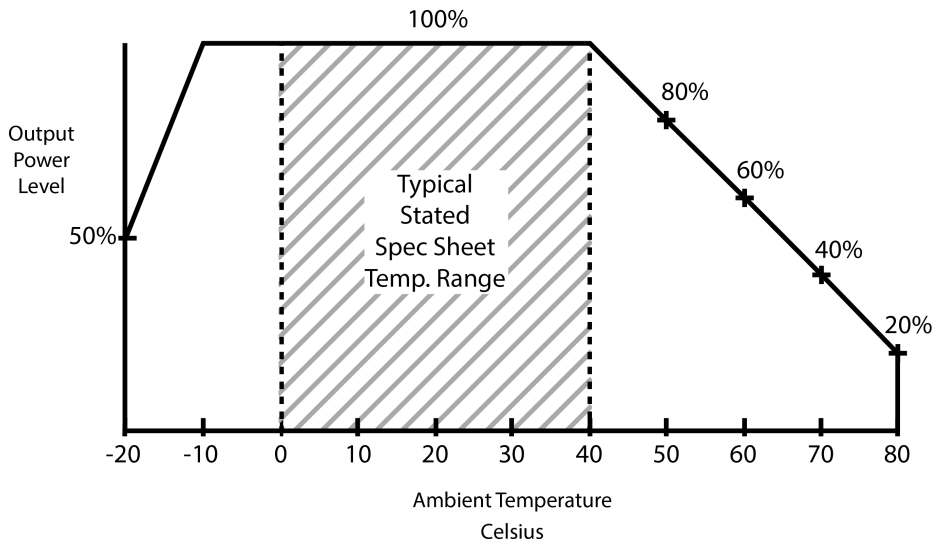

Delivering leading edge, innovative power solutions for more than **30** years....

Model:GT-83082-3612-W2

August 18, 2019

### Input Configuration

Description NEMA 1-15P, North America Blades, Class II 2 Conductors

All NEMA 1 devices are two-wire non-grounding devices (hot-neutral) rated for 125 V maximum. NEMA 1-15P plugs have two parallel flat blades, 0.25 inches (6.35 mm) wide, 0.06 inches (1.524 mm) thick, 0.625-0.718 inches (15.875–18.256 mm) long, and spaced 0.5 inches (12.7 mm) apart.



Delivering leading edge, innovative power solutions for more than 30 years....

Model:GT-83082-3612-W2

August 18, 2019

**Output Configuration**

Common output connector options:

 L Type (Coaxial  
5.5x2.5mm plug)

 C Type (Coaxial  
5.5x2.1mm plug)

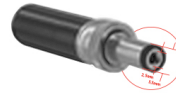
 K Type (Coaxial  
3.5x1.3mm plug)

 LL Type (5.5x2.5mm  
Locking 760k type)

 CL Type (5.5x2.1mm  
Locking S761k type)

 ML2 Type (Molex  
housing 43025-0200)

YL3 Type (KPPX-3P)



YL4 Type (KPPX-4P)

 EJ1/2/3/4/5 (EIAJ  
RC-5320A type  
connectors)

MSB Type (Micro USB)

 USBC Type (USB Type  
C)

 Inquire for custom  
design

 For a comprehensive list of options, [click here](#)









Contact GlobTek for your specific requirements or custom solutions.

Delivering leading edge, innovative power solutions for more than 30 years....

Model:GT-83082-3612-W2

August 18, 2019

## Approvals

Logo	Description
	Attention Mark / Refer to operating manual for operating and service instructions
No Logo Applicable	CB report 60950-1 2nd Ed
	CE Mark: tested to comply with EN55022:2006/A1:2007 Class B, EN610003-2, EN610003-3 including EN61000-4-2, EN61000-4-3, EN61000-4-4, EN61000-4-5, EN61000-4-6N EN61000-4-11; EMI: Complies with EN55011 CLASS B and FCC Part 15B - On label or Molded in case
	UL60950-1, cULus to UL 60950-1, 2nd Edition, 2007-03-27 and CSA C22.2 No. 60950-1-07, 2nd Edition, 2007-03
	Indoor Use Only - Mark is on the label or Molded in the case
<b>EFFICIENCY LEVEL</b> 	Efficiency: complies to section 301 of Energy Independence and Security Act (EISA) complies with Energy Star tier 2 (North America), ECP tier 2 (China), MEPS tier 2 (Australia), Code of Conduct (Europe)
LPS	Limited Power Source
 GlobTek, Inc.	JAPAN TUV Rheinland-PSE GlobTek Inc to J60950-1(H26) , J55022(H22),J3000(H25).Please follow the procedure listed in the following link for proper import to Japan: <a href="http://en.globtek.com/importing-to-japan.php">http://en.globtek.com/importing-to-japan.php</a> .
RoHS	Specifications of directive 2011/65/EU Annex VI (ROHS-2) with amendment 2015/863-EU (ROHS-3) <a href="http://www.ce-mark.com/Rohs%20final.pdf">http://www.ce-mark.com/Rohs%20final.pdf</a>
	Japan: Voluntary Control Council for Interference (VCCI)
	WEEE: Complies with EU 2012/19/EU ( <a href="http://ec.europa.eu/environment/waste/weee/index_en.htm">http://ec.europa.eu/environment/waste/weee/index_en.htm</a> ) Mark is on the label or Molded in the case