

Delivering leading edge, innovative power solutions for more than 30 years....

Model:GT-83084-WVVV-USB-W2

May 20, 2019

## DOE EPS 2.0 Level VI (6) Power Supply / Charger, 5v, 2.0A, for North America with integral USB Jack

### Information

Model Number GT-83084-WVVV-USB-W2

Description GT-83084-WVVV-USB-W2, ITE Power Supply, Wall Plug-in, AC/DC Switching Adapter with USB Power Supply AC Adaptor, , Input Rating: 100-240V- , 50/60Hz, NEMA 1-15P, North America Blades, Class II 2 Conductors, Output Rating: 10 Watts, Power rating with convection cooling (W) , 5-5.3V in 0.1V increments, Approvals: CE; Double Insulation; Level VI; PSE; RoHS; VCCI; WEEE; LPS; CB 60950; cULus;

Model Picture



Agency Documents <http://www.globtek.info/certs/GT-83084-USB-W2Z/>  
CE [https://www.globtek.com/pdf/ec\\_declaration/a0Oa000000MEsmQEAT](https://www.globtek.com/pdf/ec_declaration/a0Oa000000MEsmQEAT)  
EC-Declaration  
RoHS/RoHS2 Declaration [https://www.globtek.com/pdf/rohs\\_cert/a0Oa000000MEsmQEAT](https://www.globtek.com/pdf/rohs_cert/a0Oa000000MEsmQEAT)  
REACH Declaration [https://www.globtek.com/pdf/iso\\_certificates/REACH.pdf](https://www.globtek.com/pdf/iso_certificates/REACH.pdf)  
Conflict Minerals Declaration <https://www.globtek.com/pdf/conflict-minerals.pdf>

Delivering leading edge, innovative power solutions for more than **30** years....

Model:GT-83084-WWVV-USB-W2

May 20, 2019

**Model Parameters**

Type	Wall Plug-in
Technology	AC/DC Switching Adapter with USB Power Supply AC Adaptor
Category	ITE Power Supply
Input Voltage	100-240V~, 50/60Hz
I/P Amps (A)	0.3A
Wattage (W)	10.0
Vout Range (V)	5-5.3
Efficiency Level	VI
Ingress Protection	
Size (mm)	51.5*23.5*38.5 +/-0.3

Delivering leading edge, innovative power solutions for more than **30** years....

Model:GT-83084-WVVV-USB-W2

May 20, 2019

ENCLOSURE

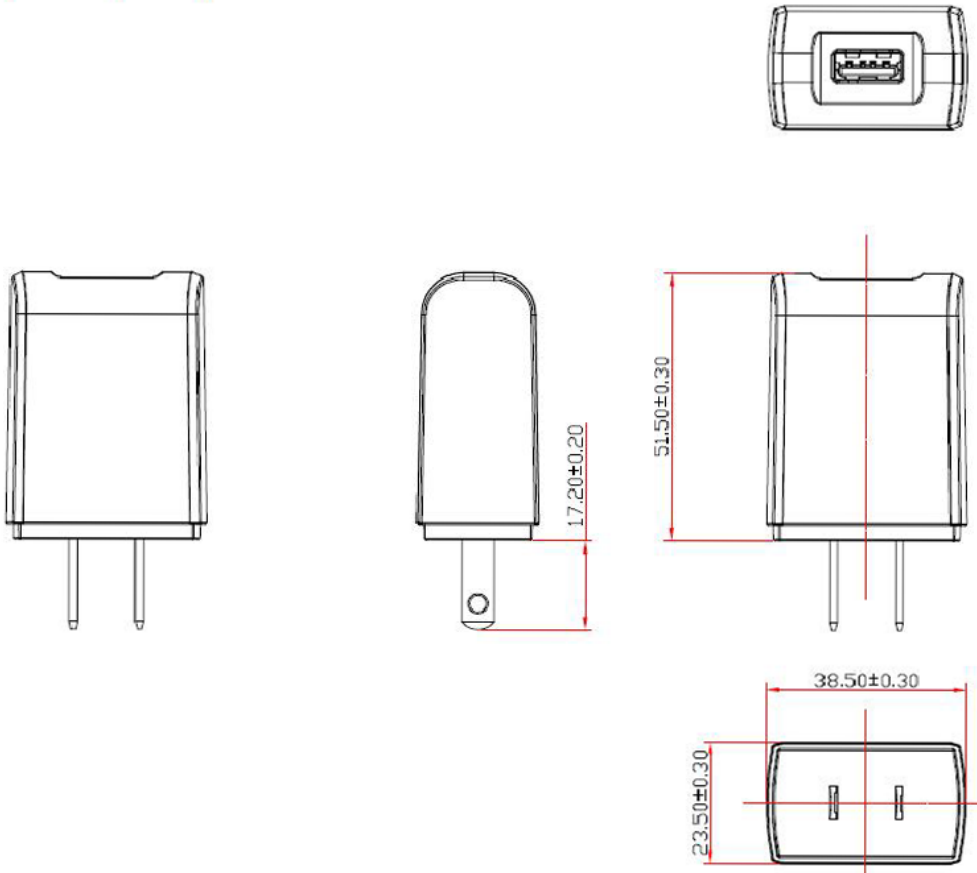

Delivering leading edge, innovative power solutions for more than **30** years....

Model:GT-83084-WVVV-USB-W2

May 20, 2019

**RATING TABLE**

Model Number	Voltage	Amps(A)	Watts(W)	RFQ
GT-83084-0806-1.0-USB-W25	1.0 V	1.5	7.50	<a href="#">RFQ</a>
GT-83084-1006-1.0-USB-W25	1.0 V	2.1	10.50	<a href="#">RFQ</a>
GT-83084-0806-0.8-USB-W25.2	0.8 V	1.5	7.80	<a href="#">RFQ</a>
GT-83084-0806-0.7-USB-W25.3	0.7 V	1.5	7.95	<a href="#">RFQ</a>

Delivering leading edge, innovative power solutions for more than 30 years....

Model:GT-83084-WWVV-USB-W2

May 20, 2019

## SPECIFICATIONS

01. Input Voltage: Specified 90-264 Vac, Nameplate rated: 100-240Vac
02. Input Frequency: Specified 47-63 Hz, Nameplate rated 50-60Hz
03. Output Regulation: +/- 5% measured at the end of a 0.6 meter USB cordset employing #22 Gauge conductors
04. Line Voltage Regulation: +/- 1% typical measured at the end of a 0.6 meter USB cordset employing #22 Gauge conductors
05. Output Ripple (Vp-p): +/-1% or 100 mV whichever is greater measured at the end of a 0.6 meter USB cordset employing #22 Gauge conductors. Measured at 20 MHz bandwidth with 0.1 uf ceramic capacitor in parallel with 10 uf electrolytic capacitor connected at the end of the output connector.
06. Hold-up Time: 5 mS minimum
07. Inrush Current: at full load, 25°C, cold start
08. Efficiency: 79% minimum, Meet standard for energy star level: VI, ERP :2009/125/EC

### B) PROTECTION

01. Over-current protection: 4A maximum with auto-recovery function
02. Over-voltage protection: 10VDC maximum with zener clamp
03. Short-circuit protection: The adapter shall not be damaged by short the DC output to Ground.

### C) SAFETY

01. Dielectric Withstand Voltage: Primary To Secondary: 3000VAC 10mA 1minute or 4242VDC 10mA 1minute
02. Leakage Current: 25mA maximum, at nominal AC input voltage and frequency
03. ESD Immunity per EN61000-4-2, ±8 kV contact, ±15 kV air, Perf Criteria A Standard.

### D) EMC

01. Emissions, per EN 55032, EN 61000-6-3, EN 61000-6-4
  - Conducted Emissions: Class B, FCC Part 15, Class B
  - Radiated Emissions: Class B, FCC Part 15, Class B
02. Line Frequency Harmonics EN61000-3-2, Class A
03. Voltage Fluctuations/Flicker EN61000-3-3
04. Immunity, per EN 55024, EN 61000-6-1, EN 61000-6-2
  - Static Discharge Immunity EN61000-4-2, 4kV Contact Discharge, 8kV air discharge
  - Radiated RF Immunity EN61000-4-3, 3V/m 80-1000MHz, 80% 1KHz AM.
  - EFT/Burst Immunity EN61000-4-4, 1kV/100kHz.
  - Line Surge Immunity EN61000-4-5, 1kV differential, 2kV common-mode
  - Conducted RF Immunity EN61000-4-6, 3Vrms, 80% 1KHz AM
  - Power Frequency Magnetic Field Immunity EN61000-4-8, 1A/m
  - Voltage Dip Immunity EN61000-4-11, Criteria

### E) OTHER:

01. MTBF: 200,000 Hours @ 25°C ambient temperature
02. Operating Temperature: -10°C to 50°C ambient temperature
03. Operating Humidity: 20 ~ 85 % RH. non-condensing
05. Storage Temperature: -20°C to 60°C
06. Storage Humidity: 5 ~ 95 % RH. non-condensing
07. Cooling: Cooling shall be with natural convection cooling
08. RoHS 2: Complies with EU 2011/65/EU China SJ/T 11364-2014

### F) ENCLOSURE

01. Housing: High impact plastic, 94V0 polycarbonate, non-vented
02. Markings: Label and/or Pad Printed and/or Molded in the case

Delivering leading edge, innovative power solutions for more than 30 years....

Model:GT-83084-WVVV-USB-W2

May 20, 2019

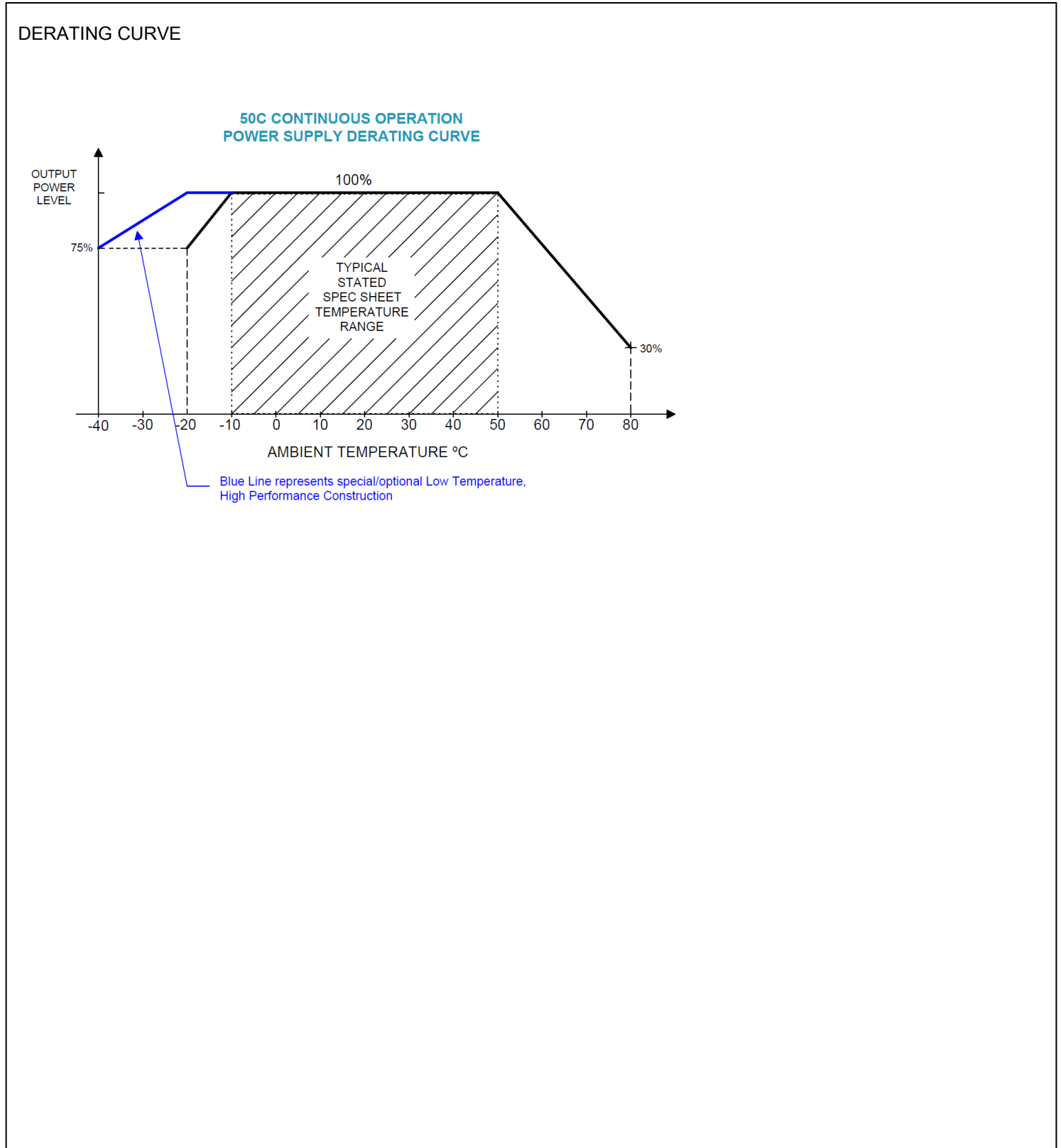

Delivering leading edge, innovative power solutions for more than **30** years....

Model:GT-83084-WVVV-USB-W2

May 20, 2019

### Input Configuration

Description NEMA 1-15P, North America Blades, Class II 2 Conductors

All NEMA 1 devices are two-wire non-grounding devices (hot-neutral) rated for 125 V maximum. NEMA 1-15P plugs have two parallel flat blades, 0.25 inches (6.35 mm) wide, 0.06 inches (1.524 mm) thick, 0.625-0.718 inches (15.875–18.256 mm) long, and spaced 0.5 inches (12.7 mm) apart.

Delivering leading edge, innovative power solutions for more than 30 years....

Model:GT-83084-WVVV-USB-W2

May 20, 2019

**Output Configuration**

Common output connector options:

 L Type (Coaxial  
5.5x2.5mm plug)

 C Type (Coaxial  
5.5x2.1mm plug)

 K Type (Coaxial  
3.5x1.3mm plug)

 LL Type (5.5x2.5mm  
Locking 760k type)

 CL Type (5.5x2.1mm  
Locking S761k type)

 ML2 Type (Molex  
housing 43025-0200)

YL3 Type (KPPX-3P)



YL4 Type (KPPX-4P)

 EJ1/2/3/4/5 (EIAJ  
RC-5320A type  
connectors)

MSB Type (Micro USB)

 USBC Type (USB Type  
C)

 Inquire for custom  
design

 For a comprehensive list of options, [click here](#)

Contact GlobTek for your specific requirements or custom solutions.









Delivering leading edge, innovative power solutions for more than **30** years....

Model:GT-83084-WWVV-USB-W2

May 20, 2019

## Approvals

Logo	Description
	Attention Mark / Refer to operating manual for operating and service instructions
No Logo Applicable	CB report 60950-1 2nd Ed
	CE Mark: tested to comply with EN55022:2006/A1:2007 Class B, EN610003-2, EN610003-3 including EN61000-4-2, EN61000-4-3, EN61000-4-4, EN61000-4-5, EN61000-4-6N EN61000-4-11; EMI: Complies with EN55011 CLASS B and FCC Part 15B - On label or Molded in case
	UL60950-1, cULus to UL 60950-1, 2nd Edition, 2007-03-27 and CSA C22.2 No. 60950-1-07, 2nd Edition, 2007-03
	Indoor Use Only - Mark is on the label or Molded in the case
<b>EFFICIENCY LEVEL VI</b>	Efficiency: complies to section 301 of Energy Independence and Security Act (EISA) complies with Energy Star tier 2 (North America), ECP tier 2 (China), MEPS tier 2 (Australia), Code of Conduct (Europe)
LPS	Limited Power Source
 GlobTek, Inc.	JAPAN TUV Rheinland-PSE GlobTek Inc to J60950-1(H26) , J55022(H22),J3000(H25).Please follow the procedure listed in the following link for proper import to Japan: <a href="http://en.globtek.com/importing-to-japan.php">http://en.globtek.com/importing-to-japan.php</a> .
RoHS	Specifications of directive 2011/65/EU Annex VI (ROHS-2) with amendment 2015/863-EU (ROHS-3) <a href="http://www.ce-mark.com/Rohs%20final.pdf">http://www.ce-mark.com/Rohs%20final.pdf</a>
	Japan: Voluntary Control Council for Interference (VCCI)
	WEEE: Complies with EU 2012/19/EU ( <a href="http://ec.europa.eu/environment/waste/weee/index_en.htm">http://ec.europa.eu/environment/waste/weee/index_en.htm</a> ) Mark is on the label or Molded in the case