

Delivering leading edge, innovative power solutions for more than 30 years....

Model:GT-83083-0505-USB-W2A

May 20, 2019

Level VI Power Supply / Charger, 5v, 1.0A, for Australia/New Zealand with integral USB Jack

Information

Model Number GT-83083-0505-USB-W2A

Description GT-83083-0505-USB-W2A, ITE Power Supply, Wall Plug-in, AC/DC Switching Adapter with USB Power Supply AC Adaptor, , Input Rating: 100-240V~, 50-60Hz, Australian AS 3112 configuration: SAA 2 pins Class II, Output Rating: 5 Watts, Power rating with convection cooling (W) , 5V in 0.1V increments, Approvals: CE; China RoHS; Double Insulation; GOST-R; Level VI; PSE; RoHS; VCCI; WEEE; CB 60950; LPS; SIQ;

Model Picture



Agency

Documents <http://www.globtek.info/certs/GT-83083-USB-W2Z/>

CE

EC-Declaration https://www.globtek.com/pdf/ec_declaration/a0Oa000000MEmwaEAD

RoHS/RoHS2

Declaration https://www.globtek.com/pdf/rohs_cert/a0Oa000000MEmwaEAD

REACH

Declaration https://www.globtek.com/pdf/iso_certificates/REACH.pdf

Conflict

Minerals <https://www.globtek.com/pdf/conflict-minerals.pdf>

Declaration

Delivering leading edge, innovative power solutions for more than **30** years....

Model:GT-83083-0505-USB-W2A

May 20, 2019

Model Parameters

Type	Wall Plug-in
Technology	AC/DC Switching Adapter with USB Power Supply AC Adaptor
Category	ITE Power Supply
Input Voltage	100-240V~, 50-60Hz
I/P Amps (A)	0.2A Max
Wattage (W)	5.0
Vout Range (V)	5
Efficiency Level	VI
Ingress Protection	
Size (mm)	71.4*37.5*25.0 +/-1.0

Delivering leading edge, innovative power solutions for more than **30** years....

Model:GT-83083-0505-USB-W2A

May 20, 2019

ENCLOSURE

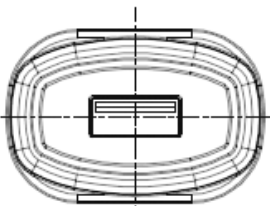
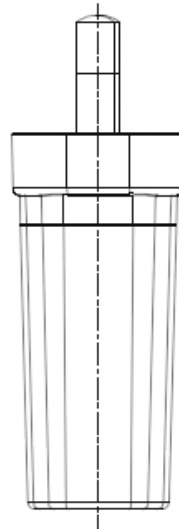
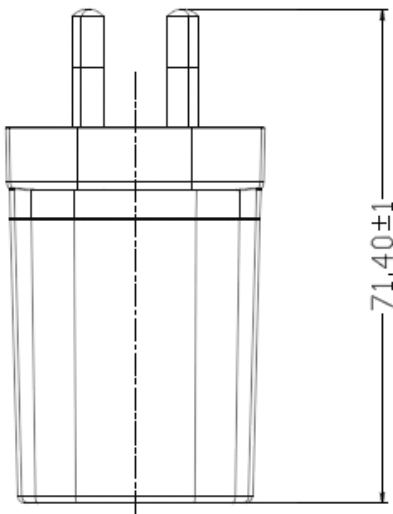
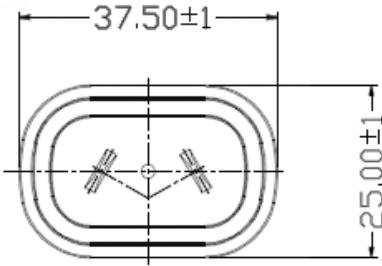

Delivering leading edge, innovative power solutions for more than **30** years....

Model:GT-83083-0505-USB-W2A

May 20, 2019

RATING TABLE

Model Number	Voltage	Amps(A)	Watts(W)	RFQ
GT-83083-0505-USB-W2A	5 V	1	5.00	RFQ
GT-83083-0506-USB-W2A	6 V	0.83	4.98	RFQ

Delivering leading edge, innovative power solutions for more than 30 years....

Model:GT-83083-0505-USB-W2A

May 20, 2019

SPECIFICATIONS

01. Input Voltage: Specified 90-264 Vac, Nameplate rated: 100-240Vac
02. Input Frequency: Specified 47-63 Hz, Nameplate rated 50-60Hz
03. Output Regulation: +/- 5% measured at the output connector measured at the end of a 0.6 meter USB cordset employing #22 Gauge conductors
04. Line Voltage Regulation: +/- 1% typical measured at the output connector measured at the end of a 0.6 meter USB cordset employing #22 Gauge conductors
05. Output Ripple (Vp-p): +/-1% or 100 mV whichever is greater measured at the end of a 0.6 meter USB cordset employing #22 Gauge conductors. Measured at 20 MHz bandwidth with 0.1 uf ceramic capacitor in parallel with 10 uf electrolytic capacitor connected at the end of the output connector.
06. Inrush Current: at full load, 25°C, cold start
07. Switching Frequency: 100 KHz typical, varies with line and load
08. Efficiency: 73.77% minimum at nominal input voltage average, Efficiency meet CEC V, ERP : 2009/125/EC

B) PROTECTION

01. Over-current protection: 1.5A maximum with auto-recovery function
02. Over-voltage protection: 10VDC maximum with zener clamp
03. Short-circuit protection: The adapter shall not be damaged by short the DC output to Ground.

C) SAFETY

01. Dielectric Withstand Voltage: Primary To Secondary: 3000VAC 10mA 1minute or 4242VDC 10mA 1minute
02. Leakage Current: 20uA maximum, at nominal AC input voltage and frequency
03. ESD Immunity per EN61000-4-2, ±8 kV contact, ±15 kV air, Perf Criteria A Standard.

D) OTHER:

01. MTBF: 200,000 Hours @ 25°C ambient temperature
02. Operating Temperature: 0°C to 50°C ambient temperature
03. Operating Humidity: 20 ~ 85 % RH. non-condensing
05. Storage Temperature: -20°C to 60°C
06. Storage Humidity: 5 ~ 95 % RH. non-condensing
07. Cooling: Cooling shall be with natural convection cooling
08. RoHS 2: Complies with EU 2011/65/EU China SJ/T 11364-2014

E) ENCLOSURE

01. Housing: High impact plastic, 94V0 polycarbonate, non-vented
02. Markings: Label and/or Pad Printed and/or Molded in the case

Delivering leading edge, innovative power solutions for more than **30** years....

Model:GT-83083-0505-USB-W2A

May 20, 2019

DERATING CURVE

Delivering leading edge, innovative power solutions for more than 30 years....

Model:GT-83083-0505-USB-W2A

May 20, 2019

Input Configuration

Description Australian AS 3112 configuration: SAA 2 pins Class II

Used in [Australia](#), [New Zealand](#), [Fiji](#), [Papua New Guinea](#) and [Tokelau](#), has two flat pins forming an inverted V-shape. These flat blades measure 6.3 by 1.5 mm with the Active and Neutral pins of 17 mm in length set 30° to the vertical on a nominal pitch of 13.7 mm. A standard power outlet in Australia provides a nominal voltage of 230 volts at a maximum of 10 amps and always includes an earth connection. As in the UK, its outlets are individually switched for extra safety. [Argentina](#) uses a similar plug, with pins 1 mm longer.

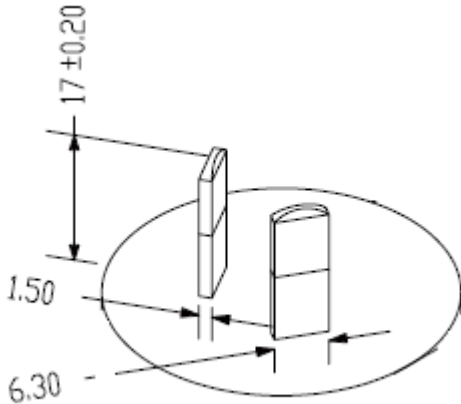

Delivering leading edge, innovative power solutions for more than 30 years....

Model:GT-83083-0505-USB-W2A

May 20, 2019

Output Configuration

Common output connector options:

 L Type (Coaxial
5.5x2.5mm plug)

 C Type (Coaxial
5.5x2.1mm plug)

 K Type (Coaxial
3.5x1.3mm plug)

 LL Type (5.5x2.5mm
Locking 760k type)

 CL Type (5.5x2.1mm
Locking S761k type)

 ML2 Type (Molex
housing 43025-0200)

YL3 Type (KPPX-3P)



YL4 Type (KPPX-4P)

 EJ1/2/3/4/5 (EIAJ
RC-5320A type
connectors)

MSB Type (Micro USB)

 USBC Type (USB Type
C)

 Inquire for custom
design

 For a comprehensive list of options, [click here](#)









Contact GlobTek for your specific requirements or custom solutions.

Delivering leading edge, innovative power solutions for more than **30** years....

Model:GT-83083-0505-USB-W2A

May 20, 2019

Approvals

Logo	Description
	Attention Mark / Refer to operating manual for operating and service instructions
No Logo Applicable	CB report 60950-1 2nd Ed
	CE Mark: tested to comply with EN55022:2006/A1:2007 Class B, EN610003-2, EN610003-3 including EN61000-4-2, EN61000-4-3, EN61000-4-4, EN61000-4-5, EN61000-4-6N EN61000-4-11; EMI: Complies with EN55011 CLASS B and FCC Part 15B - On label or Molded in case
	CHINA SJ/T 11364-2014, China RoHS Chart: http://en.globtek.com/globtek-rohs.php
	GOST-R mark for Russia(Document: http://www.globtek.com/html/iso_certificates/GT_GOST-R.pdf). 03/15/2015. Due to lack of demand, GlobTek will not be renewing it's GOST certification. Please contact your sales engineer for pricing on EAC.
	Indoor Use Only - Mark is on the label or Molded in the case
 GlobTek, Inc.	JAPAN TUV R-PSE, Cert. No. JD 50326964, to J60950-1(H26) , J55022(H22),[15V or less]. Please reference the following website for guidelines on PSE regulations: http://en.globtek.com/importing-ite-and-medical-power-supplies-ac-adaptors-to-japan/
EFFICIENCY LEVEL VI	Efficiency: complies to section 301 of Energy Independence and Security Act (EISA) complies with Energy Star tier 2 (North America), ECP tier 2 (China), MEPS tier 2 (Australia), Code of Conduct (Europe)
LPS	Limited Power Source
RoHS	Specifications of directive 2011/65/EU Annex VI (ROHS-2) with amendment 2015/863-EU (ROHS-3) http://www.ce-mark.com/Rohs%20final.pdf
 IEC/EN60950-1	SIQ Mark License EN60950-1
	Japan: Voluntary Control Council for Interference (VCCI)
	WEEE: Complies with EU 2012/19/EU (http://ec.europa.eu/environment/waste/weee/index_en.htm) Mark is on the label or Molded in the case