

Delivering leading edge, innovative power solutions for more than 30 years....

Model:GTM41080-18VV-F

August 17, 2019

## GTM41080-18VV-F

### Information

Model Number GTM41080-18VV-F

Description GTM41080-18VV-F, ITE / Medical Power Supply, 60601-1-4th Ed. , Open Frame/Internal, Regulated Switchmode AC-DC Power Supply AC Adaptor, , Input Rating: 100-240V~, 50-60 Hz, Molex 09-65-2038 3 Position Header Pin 1: Neutral, Pin 2: Removed, Pin 3: Line, Output Rating: 18 Watts, Power rating with convection cooling (W) , 5-48 (Class II)V in 0.1V increments, Approvals: Fuse 60335; CB EN/IEC 60335-1; cETLus 60601-1 3rd; CB 60601-1 2MOPP; CE; cETLus ES60601; China RoHS; Fuse 60335; Level V; NEMKO EN/IEC 60335-1; RoHS; S-Mark IEC/EN 60601-1; WEEE; CB EN/IEC 60335-1; Class I; EAC; NOM; CE; CB 60601-1; CE; Double Insulation;

Model Picture



Agency

Documents <http://www.globtek.info/certs/GTM41080/>

CE

EC-Declaration [https://www.globtek.com/pdf/ec\\_declaration/a0Oa000000J9g4DEAR](https://www.globtek.com/pdf/ec_declaration/a0Oa000000J9g4DEAR)

RoHS/RoHS2

Declaration [https://www.globtek.com/pdf/rohs\\_cert/a0Oa000000J9g4DEAR](https://www.globtek.com/pdf/rohs_cert/a0Oa000000J9g4DEAR)

REACH

Declaration [https://www.globtek.com/pdf/iso\\_certificates/REACH.pdf](https://www.globtek.com/pdf/iso_certificates/REACH.pdf)

Conflict

Minerals

Declaration <https://www.globtek.com/pdf/conflict-minerals.pdf>

Delivering leading edge, innovative power solutions for more than **30** years....

Model:GTM41080-18VV-F

August 17, 2019

**Model Parameters**

Type	Open Frame/Internal
Technology	Regulated Switchmode AC-DC Power Supply AC Adaptor
Category	ITE / Medical Power Supply
Input Voltage	100-240V~, 50-60 Hz
I/P Amps (A)	0.6A
Wattage (W)	18.0
Vout Range (V)	5-48 (Class II)
Efficiency Level	V
Ingress Protection	IPX0
Size (mm)	74*44*34

Delivering leading edge, innovative power solutions for more than 30 years....

Model:GTM41080-18VV-F

August 17, 2019

ENCLOSURE

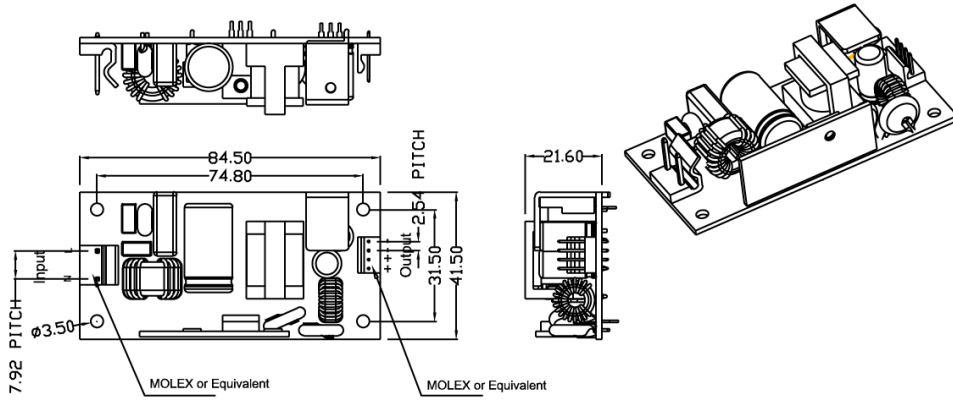

Delivering leading edge, innovative power solutions for more than **30** years....

Model:GTM41080-18VV-F

August 17, 2019

**RATING TABLE**

Model Number	Voltage	Amps(A)	Watts(W)	RFQ
a17a00000LICsk	V			<a href="#">RFQ</a>
GTM41080-1507-2.0-F	5 V	3.6	18.00	<a href="#">RFQ</a>
GTM41080-1507-1.0-F	6 V	2.5	15.00	<a href="#">RFQ</a>
GTM41080-1507-F(Class II)	7 V	2.14	14.98	<a href="#">RFQ</a>
GTM41080-1511-3.5-F(Class II)	7.5 V	2	15.00	<a href="#">RFQ</a>
GTM41080-1811-2.0-F(Class II)	9 V	2	18.00	<a href="#">RFQ</a>
GTM41080-1811-1.0-F(Class II)	10 V	1.8	18.00	<a href="#">RFQ</a>
GTM41080-1817.9-5.9-F(Class II)	12 V	1.5	18.00	<a href="#">RFQ</a>
GTM41080-1817.9-2.9-F(Class II)	15 V	1.2	18.00	<a href="#">RFQ</a>
GTM41080-1830-12.0-F(Class II)	18 V	1	18.00	<a href="#">RFQ</a>
GTM41080-1830-11.0-F(Class II)	19 V	0.94	17.86	<a href="#">RFQ</a>
GTM41080-1830-10.0-F(Class II)	20 V	0.9	18.00	<a href="#">RFQ</a>
GTM41080-1830-6.0-F	24 V	0.75	18.00	<a href="#">RFQ</a>
GTM41080-1830-F(Class II)	30 V	0.6	18.00	<a href="#">RFQ</a>
GTM41080-1848-12.0-F(Class II)	36 V	0.5	18.00	<a href="#">RFQ</a>
GTM41080-1848-8.0-F(Class II)	40 V	0.45	18.00	<a href="#">RFQ</a>
GTM41080-1848-F(Class II)	48 V	0.375	18.00	<a href="#">RFQ</a>

Delivering leading edge, innovative power solutions for more than 30 years....

Model:GTM41080-18VV-F

August 17, 2019

**SPECIFICATIONS****A) ELECTRICAL SPECIFICATIONS:**

01. Input Voltage: 100-240 Vac
02. Input Frequency: 47 - 63 Hz
03. Output Regulation: +/- 5% measured at the output connector
04. Line Voltage Regulation: +/- 1% typical measured at full load
05. Output Ripple (Vp-p): +/-1% or 150 mV whichever is greater, measured at 20 MHz bandwidth with 0.1 uf ceramic capacitor in parallel with 10 uf electrolytic capacitor connected at the end of the output connector at nominal line
06. Turn-ON/OFF Overshoot: 5% maximum, 1 mS typical recovery time for 25% to 50% step load
07. Turn-ON Delay: 3000 mS, maximum @ full load, nominal line
08. Hold-Up Time: 8 mS typical @ nominal input voltage and full load
09. Inrush Current: 30A maximum cold start @ 240Vac input
10. Switching Frequency: 65 KHz typical
11. Efficiency: Compliant with Worldwide Level V standards.
12. No Load Standby Power: <0.3 W

**B) PROTECTION**

01. Over-Voltage: Electronically Protected Zener clamp across the output
02. Short Circuit: Electronically Protected unit will auto recover upon removal of fault
04. Input Protection: Input line and neutral fusing

**C) SAFETY**

01. Protection class: Factory configured and labeled as Class I Functional Earth equipment. May be used as Class II equipment by physically removing(cutting) the Functional Earth terminal from the input connector (as provisioned by CB report). May be ordered as Class II with a 2 circuit input connector and double-box marking under an alternate ordering part number.
02. Dielectric Withstand Voltage: 5656Vdc from primary to secondary
03. Earth Leakage Current: <0.25 mA at 240Vac input voltage

**D) OTHER:**

01. MTBF: 200,000 Hours @ 25°C ambient temperature
02. Operating Temperature: 0°C to 40°C ambient temperature
03. Humidity: 0% to 90% relative humidity
04. Storage Temperature: -10°C to 80°C
05. Cooling: Convection

**E) ENCLOSURE**

01. Open Frame
02. Size: 84.5\*41.5\*21.6 mm +/-1.0 mm (3.3\*1.6\*0.9 inches)
03. Markings: Label

Delivering leading edge, innovative power solutions for more than **30** years....

Model:GTM41080-18VV-F

August 17, 2019

DERATING CURVE

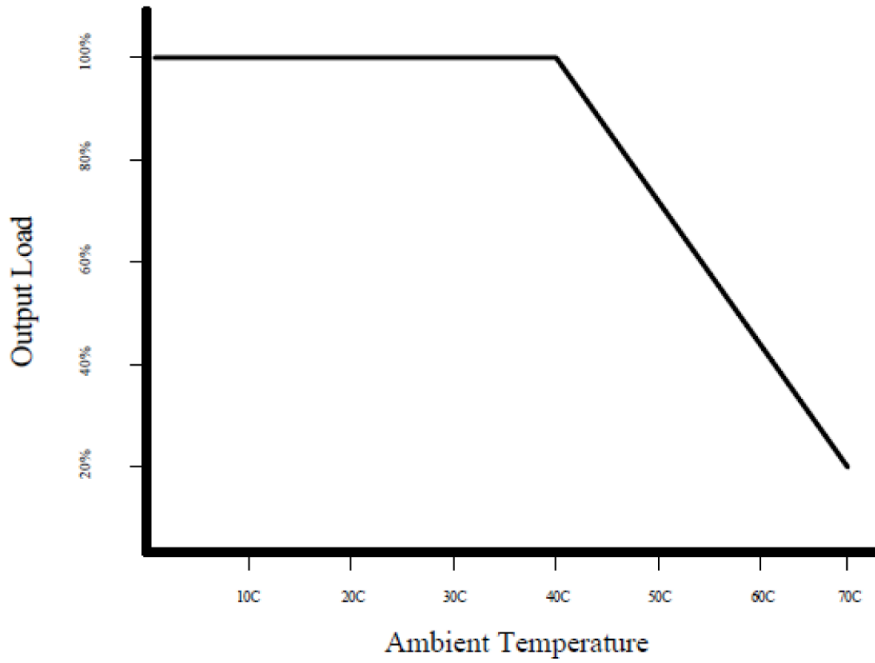

Delivering leading edge, innovative power solutions for more than **30** years....

Model:GTM41080-18VV-F

August 17, 2019

### Input Configuration

Description Molex 09-65-2038 3 Position Header Pin 1: Neutral, Pin 2: Removed, Pin 3: Line

Document: [http://www.molex.com/pdm\\_docs/sd/009652038\\_sd.pdf](http://www.molex.com/pdm_docs/sd/009652038_sd.pdf)Catalog Page: [http://www.molex.com/molex/products/datasheet.jsp?part=active/0009652038\\_PCB\\_HEADERS.xml](http://www.molex.com/molex/products/datasheet.jsp?part=active/0009652038_PCB_HEADERS.xml)

### Mates With Part(s):









[5195](#) SPOX™ Crimp Housing, [5239](#) KK® Crimp Housing

Delivering leading edge, innovative power solutions for more than 30 years....

Model:GTM41080-18VV-F

August 17, 2019

## Approvals

















Logo	Description
	Book 60335 up to 36 Volts
	Book 60335 up to 36 Volts
No Logo Applicable	CB to IEC 60601-1:2005 (Third Edition) + CORR. 1:2006 + CORR. 2:2007 + A1:2012 (or IEC 60601-1: 2012 reprint)
No Logo Applicable	CB to IEC 60601-1:2005 (Third Edition) + CORR. 1:2006 + CORR. 2:2007 + A1:2012 (or IEC 60601-1: 2012 reprint)
No Logo Applicable	CB report IEC 60601-1: 2005 + CORR. 1 (2006) + CORR. 2 (2007) and or EN 60601-1:2006 3rd Edition 2xMOPP
No Logo Applicable	CB to 60335-1:2010 (Fifth Edition) incl. Corr. 1:2010 and Corr. 2:2011 + A1:2013
No Logo Applicable	CB to 60335-1:2010 (Fifth Edition) incl. Corr. 1:2010 and Corr. 2:2011 + A1:2013
No Logo Applicable	CB to 60335-1 5th Edition (Safety of Household and Similar Electrical Appliances, Part 1: General Requirements) CB Report/ Certificate IEC 60335-1:2010 Up to 36 volts only
No Logo Applicable	CB to 60335-1 5th Edition (Safety of Household and Similar Electrical Appliances, Part 1: General Requirements) CB Report/ Certificate IEC 60335-1:2010 Up to 36 volts only
No Logo Applicable	CB to 60601-1 3rd Edition 2xMOPP, CB Certificate: IEC 60601-1:2005, CB report: IEC 60601-1: 2005 + CORR. 1 (2006) + CORR. 2 (2007) and EN 60601-1:2006
	CE Certification CE Mark: tested to comply with EN 55032.2012+AC.2013 EN 61000-3-2.2014 EN 61000-3-3.2013 EN 60601-1-2.2015 EN 55024.2010
	CE Certification CE Mark: tested to comply with EN 55032.2012+AC.2013 EN 61000-3-2.2014 EN 61000-3-3.2013 EN 60601-1-2.2015 EN 55024.2010
	CE Mark: tested to comply with EN 60601-1-2:2015 Medical electrical equipment Part 1-2: - Mark is on the label or Molded in the case
	CE Mark: tested to comply with EN 60601-1-2:2015 Medical electrical equipment Part 1-2: - Mark is on the label or Molded in the case
	CE Mark: tested to comply with EN 60601-1-2:2015 Medical electrical equipment Part 1-2: - Mark is on the label or Molded in the case
	CE Mark: tested to comply with EN 60601-1-2:2015 Medical electrical equipment Part 1-2: - Mark is on the label or Molded in the case
Conforms to ANSI/AAMI ES 60601-1:2005 Cert.to CAN/CSA Std. C22.2	cETLus ANSI_AAMI ES60601-1_2005
Conforms to ANSI/AAMI ES 60601-1:2005 Cert.to CAN/CSA Std. C22.2	cETLus ANSI_AAMI ES60601-1_2005



Delivering leading edge, innovative power solutions for more than 30 years....

Model:GTM41080-18VV-F





August 17, 2019

	cETLus-Cert-4007497 ANSI/AAMI ES60601-1:2005 with AMD C1: 2009, AMD C2: 2010 and CAN/CSA-C22.2 No. 60601-1 2008 with COR 2:2011+ANSI/AAMI HA60601-1-11 Ed:1
	cETLus-Cert-4007497 ANSI/AAMI ES60601-1:2005 with AMD C1: 2009, AMD C2: 2010 and CAN/CSA-C22.2 No. 60601-1 2008 with COR 2:2011+ANSI/AAMI HA60601-1-11 Ed:1
	CHINA SJ/T 11364-2014, China RoHS Chart: <a href="http://en.globtek.com/globtek-rohs.php">http://en.globtek.com/globtek-rohs.php</a>
	CHINA SJ/T 11364-2014, China RoHS Chart: <a href="http://en.globtek.com/globtek-rohs.php">http://en.globtek.com/globtek-rohs.php</a>
	Class I Earth Ground
	Certification # TC RU AR46.B.75423 Custom Union of Russia, Belarus and Kazakhstan
T1.6A 250VAC 	Fuse 60335 T1.6A 250VAC Up to 36 volts
T1.6A 250VAC 	Fuse 60335 T1.6A 250VAC Up to 36 volts
 	Indoor Use Only - Mark is on the label or Molded in the case
	Indoor Use Only - Mark is on the label or Molded in the case
<b>EFFICIENCY LEVEL</b>	 Efficiency: complies to section 301 of Energy Independence and Security Act (EISA) complies with Energy Star tier 2 (North America), ECP tier 2 (China), MEPS tier 2 (Australia), Code of Conduct (Europe)
<b>EFFICIENCY LEVEL</b>	 Efficiency: complies to section 301 of Energy Independence and Security Act (EISA) complies with Energy Star tier 2 (North America), ECP tier 2 (China), MEPS tier 2 (Australia), Code of Conduct (Europe)
	NEMKO IEC/EN 60335-1 (Safety of Household and Similar Electrical Appliances, Part 1: General Requirements) up to 36 Volts
	NEMKO IEC/EN 60335-1 (Safety of Household and Similar Electrical Appliances, Part 1: General Requirements) up to 36 Volts
	NOM (Mexico) to NOM-001-SCFI-1993 GTM41080-1507-2.0 5V only
Fuente de alimentación	
	NOM (Mexico) to NOM-001-SCFI-1993 GTM41080-1507-2.0 5V only
Fuente de alimentación	

Delivering leading edge, innovative power solutions for more than **30** years....

Model:GTM41080-18VV-F

August 17, 2019

RoHS	Specifications of directive 2011/65/EU Annex VI (ROHS-2) with amendment 2015/863-EU (ROHS-3) <a href="http://www.ce-mark.com/Rohs%20final.pdf">http://www.ce-mark.com/Rohs%20final.pdf</a>
RoHS	Specifications of directive 2011/65/EU Annex VI (ROHS-2) with amendment 2015/863-EU (ROHS-3) <a href="http://www.ce-mark.com/Rohs%20final.pdf">http://www.ce-mark.com/Rohs%20final.pdf</a>
	Semko S-Mark-Cert-EN60601-1 3rd Edition ( <a href="http://www.intertek.com/marks/s/">http://www.intertek.com/marks/s/</a> )
	Semko S-Mark-Cert-EN60601-1 3rd Edition ( <a href="http://www.intertek.com/marks/s/">http://www.intertek.com/marks/s/</a> )
	WEEE: Complies with EU 2012/19/EU ( <a href="http://ec.europa.eu/environment/waste/weee/index_en.htm">http://ec.europa.eu/environment/waste/weee/index_en.htm</a> ) Mark is on the label or Molded in the case
	WEEE: Complies with EU 2012/19/EU ( <a href="http://ec.europa.eu/environment/waste/weee/index_en.htm">http://ec.europa.eu/environment/waste/weee/index_en.htm</a> ) Mark is on the label or Molded in the case