

Delivering leading edge, innovative power solutions for more than **30** years....

Model:GTM43007-AWWVV-FW

June 24, 2019

**2" x 3" (2x3") Ultra Compact AC-DC Switching Power Supplies available in 60601-1 Medical, 60950-1 ITE, and 60335-1 Household with Class II and up to 60W output power**

**Information**

**Model Number** GTM43007-AWWVV-FW

GTM43007-AWWVV-FW, Medical/ITE/Household use Power Supply, 60601-1-4th Ed. , Open Frame/Internal, Regulated Switchmode AC-DC Power Supply AC Adaptor, , Input Rating: 100-240V~, 50-60 Hz, Molex 26-60-4030 3 Position Header Pin 1:

**Description**

Line, Pin 2: Removed, PIN 3: Neutral, Output Rating: 60 Watts, Power rating with convection cooling (W) , 5-48V in 0.1V increments, Approvals: CB 62368; ETL 62368; EAC; cETLus; cETLus; Book 60601; China RoHS; WEEE; Ukraine; RoHS; CB 60601-1 2MOPP; CE; Double Insulation; CE; FCC; LPS; CB 60950; CB EN/IEC 60335-1; cETLus 60601-1 3rd; NEMKO EN/IEC 60335-1; S-Mark IEC/EN 60601-1 60950; Level V; Fuse60335; WDaE; Fuse 60335;



Model Picture

- Agency Documents <http://www.globtek.info/certs/GTM43007/>
- CE EC-Declaration [https://www.globtek.com/pdf/ec\\_declaration/a0Oa000000HTZh6EAH](https://www.globtek.com/pdf/ec_declaration/a0Oa000000HTZh6EAH)
- RoHS/RoHS2 Declaration [https://www.globtek.com/pdf/rohs\\_cert/a0Oa000000HTZh6EAH](https://www.globtek.com/pdf/rohs_cert/a0Oa000000HTZh6EAH)
- REACH Declaration [https://www.globtek.com/pdf/iso\\_certificates/REACH.pdf](https://www.globtek.com/pdf/iso_certificates/REACH.pdf)
- Conflict Minerals <https://www.globtek.com/pdf/conflict-minerals.pdf>

Delivering leading edge, innovative power solutions for more than **30** years....

Model:GTM43007-AWWVV-FW

June 24, 2019

Declaration

Delivering leading edge, innovative power solutions for more than **30** years....

Model:GTM43007-AWWVV-FW

June 24, 2019

**Model Parameters**

Type	Open Frame/Internal
Technology	Regulated Switchmode AC-DC Power Supply AC Adaptor
Category	Medical/ITE/Household use Power Supply
Input Voltage	100-240V~, 50-60 Hz
I/P Amps (A)	1.5 A
Wattage (W)	60.0
Vout Range (V)	5-48
Efficiency Level	N/A
Ingress Protection	N/A
Size (mm)	76.2x50.8x23.6 for 5V-14V models, 76.2x50.8x22.5 for 15V-48V models

Delivering leading edge, innovative power solutions for more than 30 years....

Model:GTM43007-AWWWV-FW

June 24, 2019

**ENCLOSURE**

Top Diagram is for 5V-14V models, Bottom Diagram is for 15V-48V models

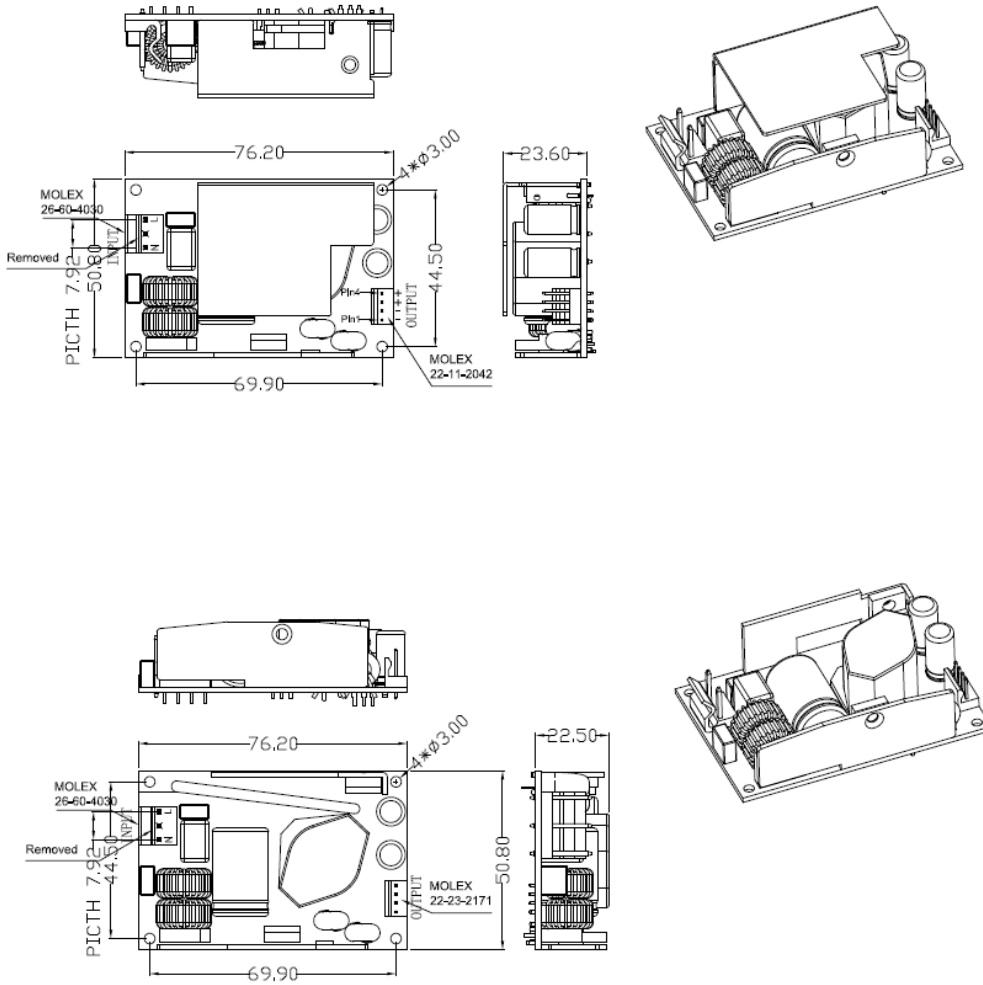

Alternative configuration with different input and output connectors. Product PN# ends with suffix "FWJST"

Delivering leading edge, innovative power solutions for more than 30 years....

Model:GTM43007-AWWVV-FW

June 24, 2019

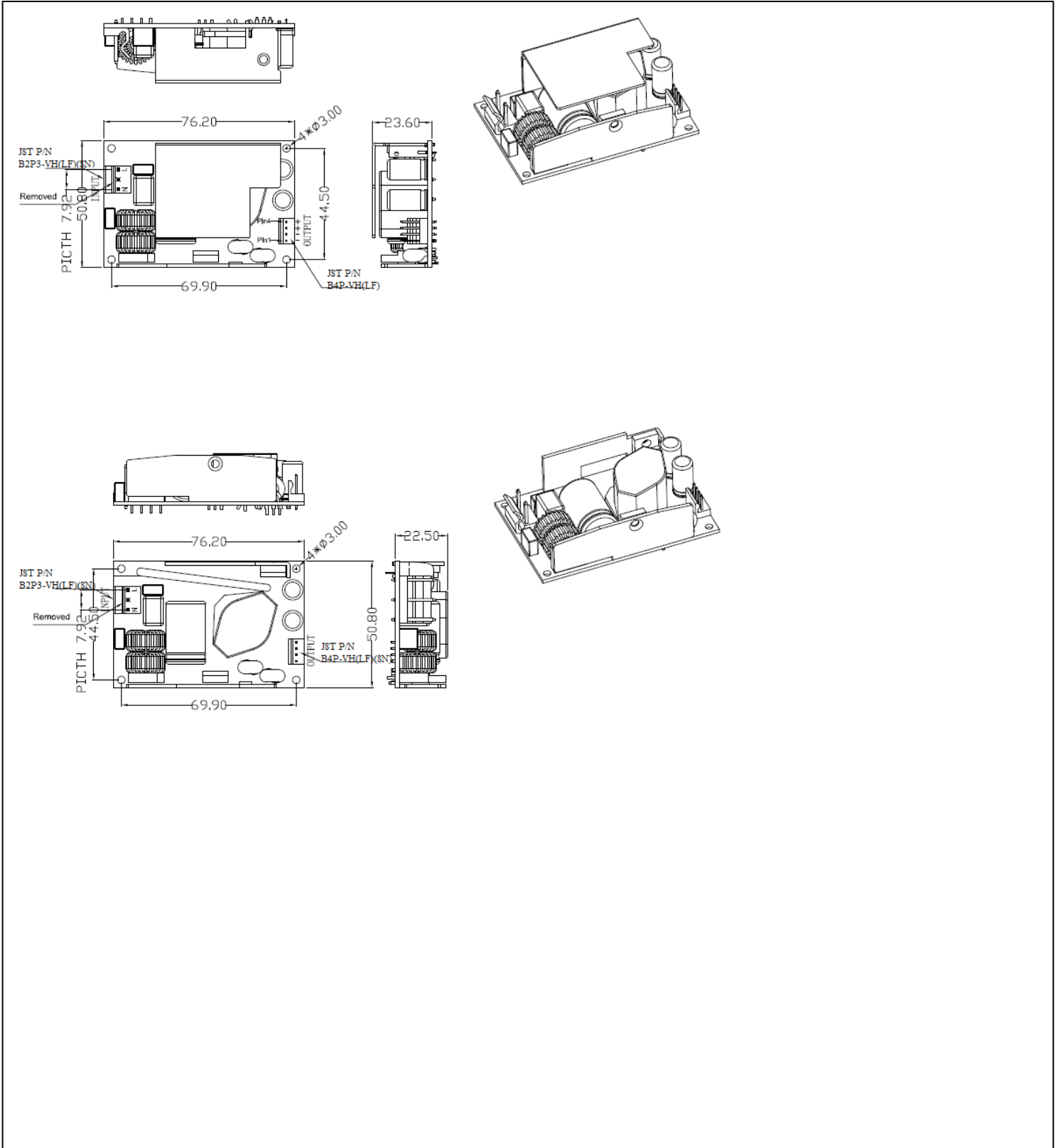

Delivering leading edge, innovative power solutions for more than **30** years....

Model:GTM43007-AWWVV-FW

June 24, 2019

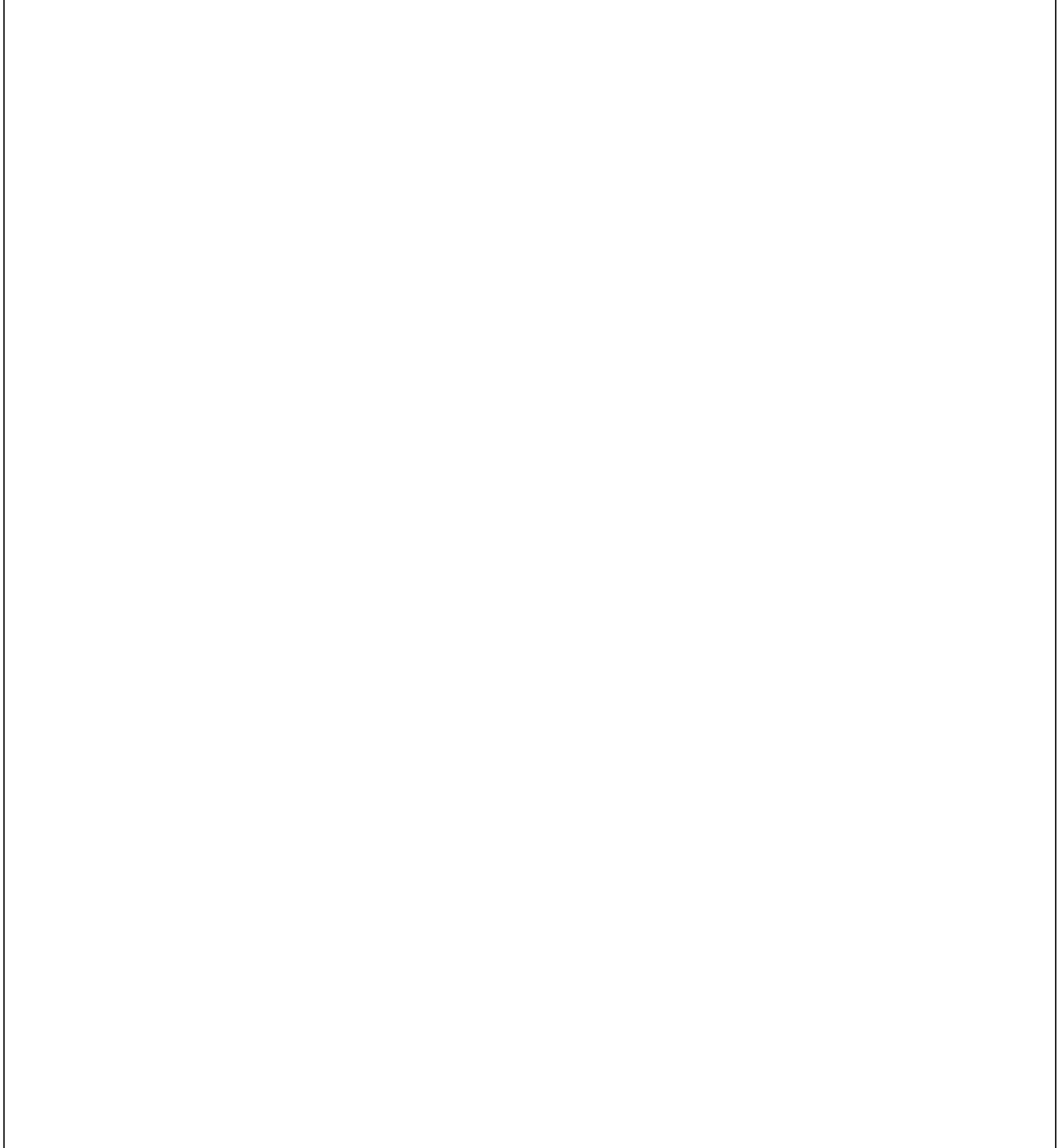

Delivering leading edge, innovative power solutions for more than **30** years....

Model:GTM43007-AWWWV-FW

June 24, 2019

**RATING TABLE**

Model Number	Voltage	Amps(A)	Watts(W)	RFQ
GTM43007-A3005-FW	5 V	6	30.00	<a href="#">RFQ</a>
GTM43007-A3007-1.0-FW	6 V	5	30.00	<a href="#">RFQ</a>
GTM43007-A3007-FW	7 V	4.28	29.96	<a href="#">RFQ</a>
GTM43007-A3809-1.5-FW	7.5 V	5	37.50	<a href="#">RFQ</a>
GTM43007-A4509-1.5-FW	7.5 V	6	45.00	<a href="#">RFQ</a>
GTM43007-A4509-FW	9 V	5	45.00	<a href="#">RFQ</a>
GTM43007-A4512-2.0-FW	10 V	4.5	45.00	<a href="#">RFQ</a>
GTM43007-A6012-FW	12 V	5	60.00	<a href="#">RFQ</a>
GTM43007-A4512-FW	12 V	3.75	45.00	<a href="#">RFQ</a>
GTM43007-A6015-1.2-FW	13.8 V	4.347	59.99	<a href="#">RFQ</a>
GTM43007-A3515-FW	15 V	2.333	35.00	<a href="#">RFQ</a>
GTM43007-A6015-FW	15 V	4	60.00	<a href="#">RFQ</a>
GTM43007-A6015-FW	15 V	4	60.00	<a href="#">RFQ</a>
GTM43007-A1018-FW	18 V	0.555	9.99	<a href="#">RFQ</a>
GTM43007-A6018-FW	18 V	3.333	59.99	<a href="#">RFQ</a>
GTM43007-A6024-5.0-FW	19 V	3.15	59.85	<a href="#">RFQ</a>
GTM43007-A5524-5.0-FW	19 V	2.89	54.91	<a href="#">RFQ</a>
GTM43007-A6024-4.0-FW	20 V	3	60.00	<a href="#">RFQ</a>
GTM43007-A6024-FW	24 V	2.5	60.00	<a href="#">RFQ</a>
GTM43007-A6036-8.4-FW	27.6 V	2.18	60.17	<a href="#">RFQ</a>
GTM43007-A6036-6.0-FW	30 V	2	60.00	<a href="#">RFQ</a>
GTM43007-A5136-2.5-FW	33.5 V	1.5	50.25	<a href="#">RFQ</a>
GTM43007-A6036-2.5-FW	33.5 V	1.79	59.97	<a href="#">RFQ</a>
GTM43007-A6036-FW	36 V	1.66	59.76	<a href="#">RFQ</a>
GTM43007-A6048-8.0-FW	40 V	1.5	60.00	<a href="#">RFQ</a>
GTM43007-A6048-FW	48 V	1.25	60.00	<a href="#">RFQ</a>

Delivering leading edge, innovative power solutions for more than 30 years....

Model:GTM43007-AWWVV-FW

June 24, 2019

**SPECIFICATIONS****A) ELECTRICAL SPECIFICATIONS:**

01. Input Voltage: Specified 90-264 Vac, Nameplate rated: 100-240Vac
02. Input Frequency: Specified 47-63 Hz, Nameplate rated 50-60Hz
03. Output Regulation: +/- 3% measured at the output connector
04. Line Voltage Regulation: +/- 0.5% maximum measured at full load
05. Output Ripple (Vp-p): +/- 1% of output voltage, Vp-p, max
06. Turn-ON/OFF: 5% maximum, 1 mS typical recovery time for 25% step load
07. Turn-ON Delay: 1 Sec max
08. Hold-Up Time: 10 mS typical @ nominal input voltage and full load
09. Inrush Current: 30A maximum @ 115 Vac input, 60A maximum @ 230 Vac input
10. Switching Frequency: 65 KHz typical
11. Efficiency: 87% @115Vac, 89% @ 230Vac typical at full load
12. No Load Power: < 300mW @ 230Vac

**B) PROTECTION**

01. Overvoltage Protection: 110% to 130% of nominal output voltage, and less than 60Vdc
02. Short Circuit/Over-load: momentary short circuit protected, output will auto recover upon removal of short

**C) SAFETY**

01. Dielectric Withstand Voltage: 4000Vac / 5656Vdc from primary to secondary
02. Earth Leakage Current: Does not exceed 300uA in NORMAL CONDITION and 1000uA in SINGLE FAULT CONDITION
03. Output Leakage Current: Does not exceed 75uA NC(Normal condition) 300uA SFC(single fault condition)
05. Earth continuity test:<0.1 Ohm, Class I Only
06. Mode of operation: Continuous
07. Means of Protection: 2 x MOPP
08. Compliant Standards: See listings at end of this drawing for specifics

**D) EMC**EN 60601-1-2, 4<sup>th</sup> edition

Emissions, per EN 55032, EN 61000-6-3, EN 61000-6-4

Conducted Emissions: Class B, FCC Part 15, Class B

Radiated Emissions: Class B, FCC Part 15, Class B

Line Frequency Harmonics EN61000-3-2, Class A

Voltage Fluctuations/Flicker EN61000-3-3

Immunity, per EN 55024, EN 61000-6-1, EN 61000-6-2

Static Discharge Immunity EN61000-4-2, 10kV Contact Discharge, 20kV air discharge

Radiated RF Immunity EN61000-4-3, 10V/m 80-1000MHz, 3V/m 1-2.7GHz, 80% 1KHz AM.

EFT/Burst Immunity EN61000-4-4, 4kV/100kHz.

Line Surge Immunity EN61000-4-5, 2kV differential, 4kV common-mode

Conducted RF Immunity EN61000-4-6, 3Vrms, 80% 1KHz AM

Power Frequency Magnetic Field Immunity EN61000-4-8, 3A/m

Voltage Dip Immunity EN61000-4-11, Criteria

**E) OTHER**

01. MTBF: 1,000,000 Hours @ 45°C ambient temperature, Full Load
02. Operating Temperature: -10°C to 45°C ambient temperature
03. Humidity: 0% to 95% relative humidity
04. Storage Temperature: -30°C to 80°C

**PROPRIETARY INFORMATION**

PROPRIETARY OF GLOBTEK, INC. ANY REPRODUCTION, DISCLOSURE OR USE OF THIS DRAWING, IN WHOLE OR IN PART, IS HEREBY PROHIBITED EXCEPT AS SPECIFIED IN WRITING BY GLOBTEK, INC.

<http://en.globtek.com/datasheet/id/a00a000000HTZh6>



Delivering leading edge, innovative power solutions for more than **30** years....

Model:GTM43007-AWWWV-FW

June 24, 2019

- 05. Cooling: Convection
- 06. Elevation: 5000M
- 07. ROHS 2: Complies with EU 2011/65/EU and China SJ/T 11363-2006

**F) MECHANICAL FORMAT**

- 01. Type: Open Frame
- 02. Size: A suffix version, (2"x3"), 76.2 x 50.8 x 30.5 mm
- 03. Size: B suffix version, (2"x4"), 101.6 x 50.8 x 30.5 mm
- 04. Size: C suffix version, (3"x5"), 127.0 x 76.2 x 30.5 mm

**G) SPECIAL OPTIONS**

- 01. Custom Label Markings
- 02. Short term Output Surge Capability
- 03. Reduced Leakage Current versions
- 04. Tightened output voltage tolerance
- 05. Reduced output ripple level
- 06. High Rel PCB laminate with Plated through Holes for IPC610 Class 2 Compliance
- 07. Low Temperature operation, down to -40°C
- 08. Quasi Constant Current Output, for Lead-Acid Battery Charger Applications
- 09. Special Input or Output Connectors
- 10. Over-Temperature Protection, Latched Shut-Down

Delivering leading edge, innovative power solutions for more than 30 years....

Model:GTM43007-AWWVV-FW

June 24, 2019

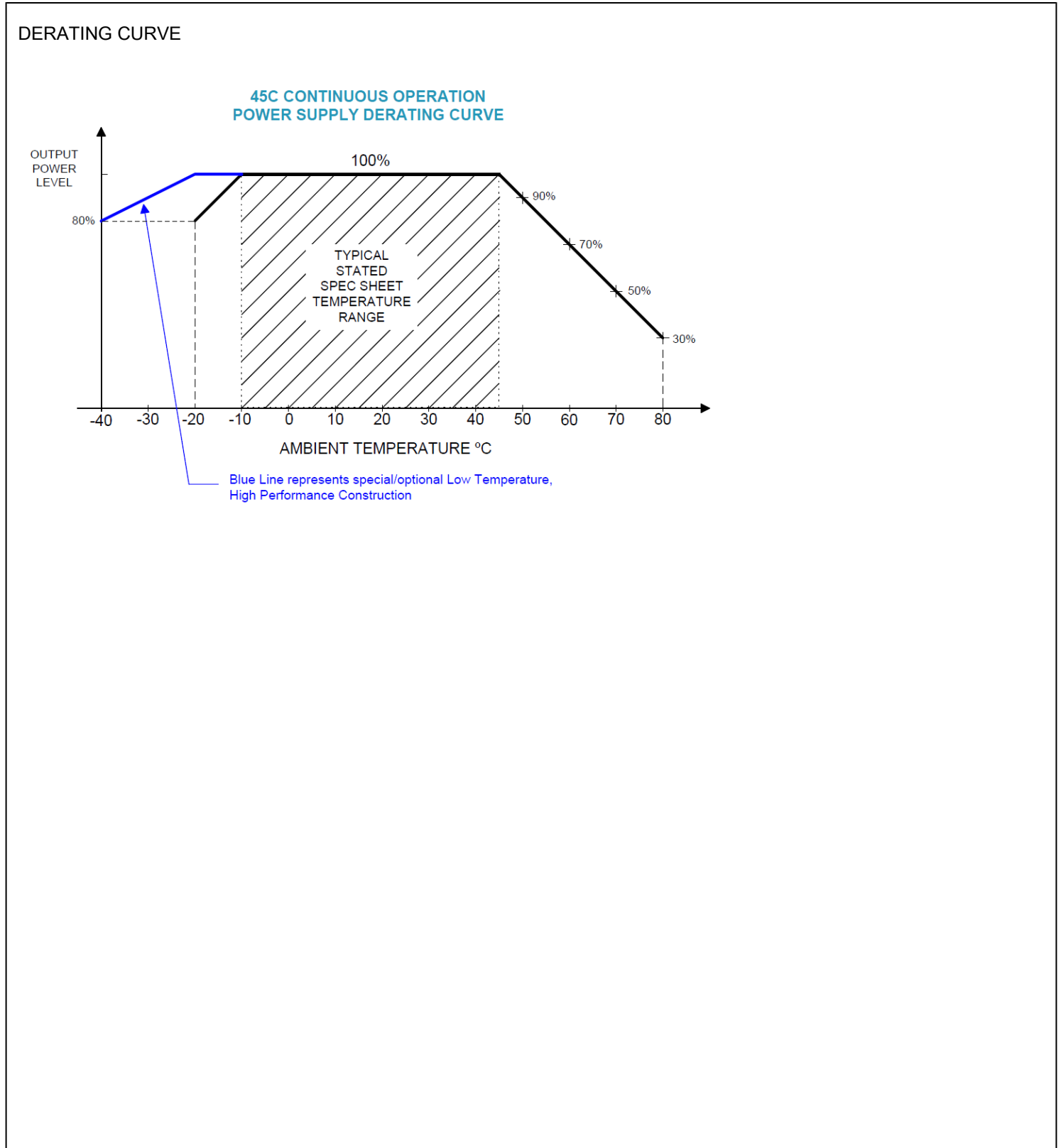

Delivering leading edge, innovative power solutions for more than 30 years....

Model:GTM43007-AWWWV-FW

June 24, 2019

**Input Configuration**

Description Molex 26-60-4030 3 Position Header Pin 1: Line, Pin 2: Removed, PIN 3: Neutral

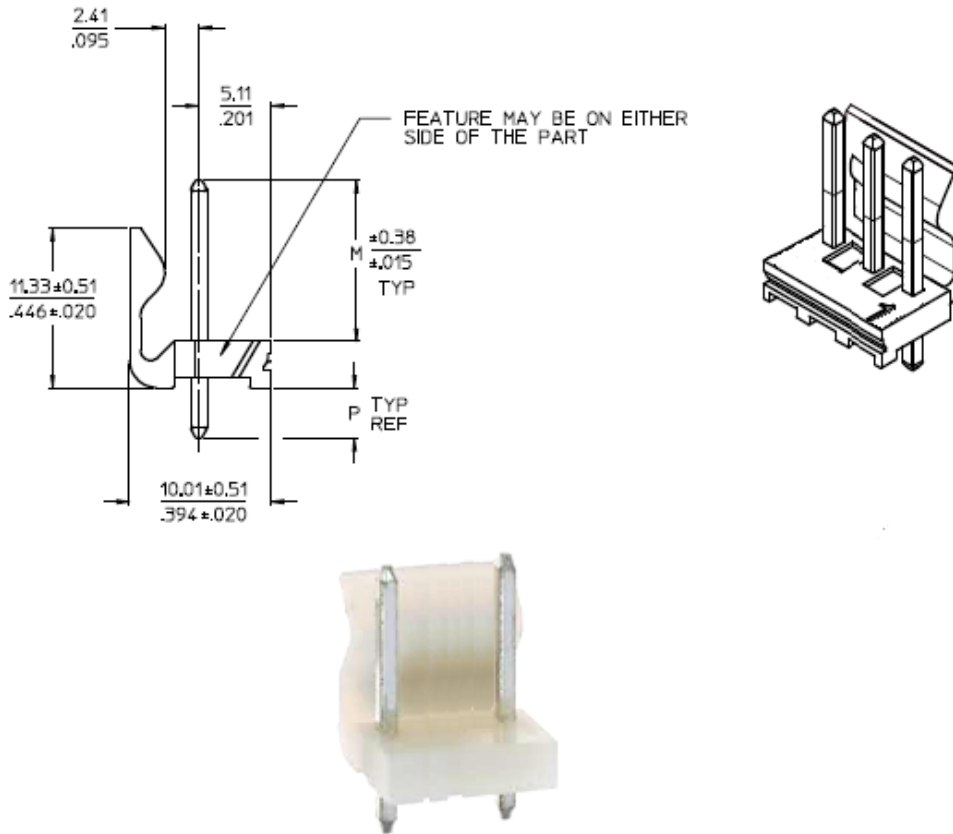

Optional Input Wiring Kits are available:

PN/Ordering No	Length	End A	End B
<a href="#">XHP410070M7MLX3(R)</a>	70JST XHP-4		Molex 09-93-0300
<a href="#">C810070M6MLX3(R)</a>	60IEC60320 C8		Molex 09-93-0300
<a href="#">C1410070M6MLX3(R)</a>	60IEC60320 C14		Molex 09-93-0300









Custom lengths, construction, cable types, ferrites, filters, and termination available upon request.

Delivering leading edge, innovative power solutions for more than 30 years....

Model:GTM43007-AWWWV-FW

June 24, 2019







## Approvals

Logo	Description
	Book 60335 up to 36 Volts
	60601-1 3rd Operating Instructions
No Logo Applicable No Logo	CB report IEC60601-1 2005 A1+C1+C2 2016-2-4 and or EN 60601-1:2006 3.1rd Edition 2xMOPP CB Report EN60950-1
No Logo Applicable	CB for IEC 62368-1:2014 (Second Edition)
No Logo Applicable	CB to 60335-1 5th Edition (Safety of Household and Similar Electrical Appliances, Part 1: General Requirements) CB Report/ Certificate IEC 60335-1:2010 Up to 36 volts only
	CE Certification CE Mark: tested to comply with EN 55032.2012+AC.2013 EN 61000-3-2.2014 EN 61000-3-3.2013 EN 60601-1-2.2015 EN 55024.2010
	CE Mark: tested to comply with EN 60601-1-2:2015 Medical electrical equipment Part 1-2: - Mark is on the label or Molded in the case
	Audio/Video, Information And Communication Technology Equipment - Part 1: Safety Requirements [UL 62368-1:2014 Ed.2] Audio/Video, Information And Communication Technology Equipment - Part 1: Safety Requirements [CSA C22.2#62368-1:2014 Ed.2]
	cETLus-Cert-4007497 ANSI/AAMI ES60601-1:2005/A1:2012 Issued: 2012/08/20 Medical electrical equipment ? Part 1: Amendment 1; CAN/CSAC22.2 No. 60601-1:14, Third Edition Issued: 2014/03/01 - Medical Electrical Equipment - Part 1
	CHINA SJ/T 11364-2014, China RoHS Chart: <a href="http://en.globtek.com/globtek-rohs.php">http://en.globtek.com/globtek-rohs.php</a>
Conforms to AAMI STD.ES60601-1,IEC 60601-1-11 Certified to CAN/CSA STD.C22.2 NO.60601-1 Conforms to UL STD. 60950-1 Certified to CSA STD C22.2 NO.60950-1	Conforms to AAMI STD.ES60601-1,IEC 60601-1-11 Certified to CAN/CSA STD.C22.2 NO.60601-1  Conforms to UL STD. 60950-1 Certified to CSA STD C22.2 NO.60950-1
	Certification # TC RU AR46.B.69004 Custom Union of Russia, Belarus and Kazakhstan
	FCC PART 15 CLASS B Fuse 60335 T2.0A 250VAC Up to 36 volts

Delivering leading edge, innovative power solutions for more than 30 years....

Model:GTM43007-AWWWV-FW

June 24, 2019

	Indoor Use Only - Mark is on the label or Molded in the case
<b>EFFICIENCY LEVEL</b> 	Efficiency: complies to section 301 of Energy Independence and Security Act (EISA) complies with Energy Star tier 2 (North America), ECP tier 2 (China), MEPS tier 2 (Australia), Code of Conduct (Europe)
LPS	Limited Power Source
 <b>IEC/EN60335-1</b>	NEMKO IEC/EN 60335-1 (Safety of Household and Similar Electrical Appliances, Part 1: General Requirements) up to 36 Volts
RoHS	Specifications of directive 2011/65/EU Annex VI (ROHS-2) with amendment 2015/863-EU (ROHS-3) <a href="http://www.ce-mark.com/Rohs%20final.pdf">http://www.ce-mark.com/Rohs%20final.pdf</a>
 Intertek <b>IEC/EN60601-1</b> <b>IEC/EN60950-1</b>	Semko S-Mark-Cert-EN60601-1 and EN60950-1
 10276	Ukraine UKRSepro (Document: <a href="http://www.globtek.com/html/iso_certificates/GT_Ukraine.pdf">www.globtek.com/html/iso_certificates/GT_Ukraine.pdf</a> )
WDaE	Appliances can be used in warm damp equable climates
	WEEE: Complies with EU 2012/19/EU ( <a href="http://ec.europa.eu/environment/waste/weee/index_en.htm">http://ec.europa.eu/environment/waste/weee/index_en.htm</a> ) Mark is on the label or Molded in the case