

Delivering leading edge, innovative power solutions for more than **30** years....

Model:GTM96600-65VV.V-R2L

August 17, 2019

## GTM96600-65VV.V-R2L

### Information

Model Number GTM96600-65VV.V-R2L

Description GTM96600-65VV.V-R2L, ITE / Medical Power Supply, 60601-1-4th Ed. , Wall Plug-in+Desktop Combination, Regulated Switchmode AC-DC Power Supply AC Adaptor, , Input Rating: 100-240V~, 50-60 Hz, IEC 60320/C8 AC Inlet connector, Output Rating: 65 Watts, Power rating with convection cooling (W) , 5-54V in 0.1V increments, Approvals: EAC; CE; China RoHS; Double Insulation; ETL; FCC; PSE; PSE; PSE; Level VI; RoHS; Ukraine; VCCI; WEEE; S-Mark IEC/EN 60601-1; CB 60601-1; CB 62368;

Model Picture



Agency

Documents <http://www.globtek.info/certs/GTM96600-TZ/>

CE

EC-Declaration [https://www.globtek.com/pdf/ec\\_declaration/a0Oa000000FifXFEAZ](https://www.globtek.com/pdf/ec_declaration/a0Oa000000FifXFEAZ)

RoHS/RoHS2

Declaration [https://www.globtek.com/pdf/rohs\\_cert/a0Oa000000FifXFEAZ](https://www.globtek.com/pdf/rohs_cert/a0Oa000000FifXFEAZ)

REACH

Declaration [https://www.globtek.com/pdf/iso\\_certificates/REACH.pdf](https://www.globtek.com/pdf/iso_certificates/REACH.pdf)

Conflict

Minerals <https://www.globtek.com/pdf/conflict-minerals.pdf>

Declaration

Delivering leading edge, innovative power solutions for more than **30** years....

Model:GTM96600-65VV.V-R2L

August 17, 2019

**Model Parameters**

Type	Wall Plug-in+Desktop Combination
Technology	Regulated Switchmode AC-DC Power Supply AC Adaptor
Category	ITE / Medical Power Supply
Input Voltage	100-240V~, 50-60 Hz
I/P Amps (A)	1.5 A
Wattage (W)	65.0
Vout Range (V)	5-54
Efficiency Level	VI
Ingress Protection	IP40, IP54 Option available
Size (mm)	136.3*54.1*37.6

Delivering leading edge, innovative power solutions for more than 30 years....

Model:GTM96600-65VV.V-R2L

August 17, 2019

ENCLOSURE

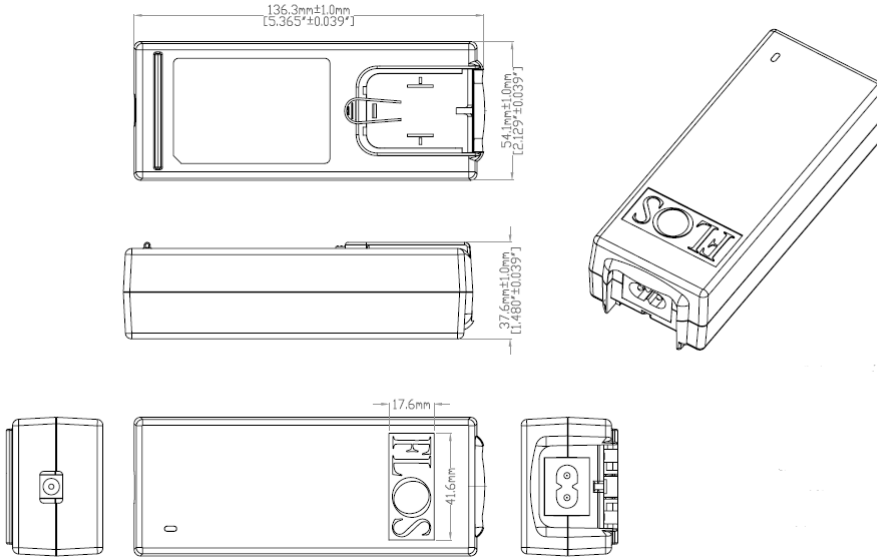

Delivering leading edge, innovative power solutions for more than **30** years....

Model:GTM96600-65VV.V-R2L

August 17, 2019

**RATING TABLE**

Model Number Voltage Amps(A) Watts(W) RFQ

Delivering leading edge, innovative power solutions for more than 30 years....

Model:GTM96600-65VV.V-R2L

August 17, 2019

**SPECIFICATIONS****A) ELECTRICAL SPECIFICATIONS:**

01. Input Voltage: Specified 90-264 Vac, Nameplate rated: 100-240Vac
  - 90-264 Vac range @ 100% of rated load current
  - 85-264 Vac range @ 85% of rated load current
  - 110-370 VDC range @ 100% of rated load current
02. Input Frequency: Specified 47-63 Hz, Nameplate rated 50-60Hz
03. Output Regulation: +/- 5% measured at the output connector
04. Line Voltage Regulation: +/- 0.5% typical measured at full load
05. Green Power On Indicator LED
06. Output Ripple (Vp-p): 1% or 100 mV whichever is greater, measured at 20 MHz bandwidth with 0.1 uf ceramic capacitor in parallel with a low impedance 47 uf electrolytic capacitor connected at the end of the output connector
07. Turn-ON/OFF Overshoot: 5% maximum, 1 mS typical recovery time for 40% to 70% step load
08. Turn-ON Delay: 1 second maximum @ full load, nominal line
09. Hold-Up Time: 8 mS typical @ nominal input voltage and full load
10. Inrush Current: 30A/60A maximum cold start @ 115/230Vac input
11. Efficiency: Compliant with Efficiency Level VI and CoC Tier 2 standards
12. No Load Standby Power: <0.075 W @ 230Vac for <= 49W output power rating,  
<0.15W @ 230Vac for > 49W output power rating

**B) PROTECTION**

01. Input Protection: Input line fusing and 300Vac MOV
02. Short Circuit/ Overload: Electronically Protected unit will auto recover upon removal of fault
  - Output Current Limit: 110% to 160% of rated output current  
(upper end of current limit range is determined by normal output power rating,  
not derated output power level)
03. Output Over-Voltage: 110% to 130% of nominal output voltage

**C) SAFETY**

01. Dielectric Withstand Voltage: 4000Vac or 5656Vdc from input to output,  
On Class I models, 3000Vac or 4242Vdc from input to earth
02. Earth Leakage Current: Class I models < 300uA, N/A for Class II models
03. Touch Current: Class I models < 20uA, Class II models < 85uA, F2 Models < 20uA
04. [Output Isolation Options](#):
  - a) C8 or C18 Inlet, Class II
  - b) C6 or C14 Inlet, Class II FE, Output Isolated from Earth contact
  - c) C6 or C14 Inlet, Class I, Output negative directly attached to Earth contact
05. Earth Continuity Test: < 0.1 Ohm between Earth Pin at AC input and PCB termination point (Class I models only)
06. Means of Protection: 2 x MOPP
07. Compliant Standards: See listings at end of this drawing for specifics

**D) EMC**

- EN 60601-1-2, 4<sup>th</sup> edition  
Emissions, per EN 55032, EN 61000-6-3, EN 61000-6-4, CISPR11 and CISPR22
- Conducted Emissions: Class B, FCC Part 15, Class B
  - Radiated Emissions: Class B, FCC Part 15, Class B
- Line Frequency Harmonics EN61000-3-2, Class A  
Voltage Fluctuations/Flicker EN61000-3-3

Immunity, per EN 55024, EN 61000-6-1, EN 61000-6-2

**PROPRIETARY INFORMATION**

PROPRIETARY OF GLOBTEK, INC. ANY REPRODUCTION, DISCLOSURE OR USE OF THIS DRAWING, IN WHOLE OR IN PART, IS HEREBY PROHIBITED EXCEPT AS SPECIFIED IN WRITING BY GLOBTEK, INC.

<http://en.globtek.com/datasheet/id/a00a000000f1xf>

Delivering leading edge, innovative power solutions for more than 30 years....

Model:GTM96600-65VV.V-R2L

August 17, 2019

Static Discharge Immunity EN61000-4-2, 10kV Contact Discharge, 20kV air discharge  
Radiated RF Immunity EN61000-4-3, 10V/m 80-1000MHz, 3V/m 1-2.7GHz, 80% 1KHz AM.  
EFT/Burst Immunity EN61000-4-4, 4kV/100kHz.  
Line Surge Immunity EN61000-4-5, 2kV differential, 4kV common-mode  
Conducted RF Immunity EN61000-4-6, 3Vrms, 80% 1KHz AM  
Power Frequency Magnetic Field Immunity EN61000-4-8, 3A/m  
Voltage Dip Immunity EN61000-4-11, Criteria

## E) OTHER:

01. MTBF: 1,000,000 Hours @ 40°C ambient temperature, Full Load
02. GTM96600 Family: -20°C to 40°C ambient temperature with full load  
Regarding Operating Temperature,
  - a- See below derating table for output power capability at alternate temperature
  - b- Extended low end temperature range available as custom option
03. Operating Humidity: 0% to 95% relative humidity, non-condensing
04. Storage Temperature: -30°C to 80°C
05. Operating Altitude: 5000 Meters
06. ROHS: Compliant with latest regulations, see approvals section below

## F) ENCLOSURE

01. Housing: High impact plastic, 94V0 polycarbonate, non-vented
02. Markings: Label or Laser Printed
03. AC Input mechanical options: Desktop C6, C8, C14 or C18 IEC Inlet.  
Hybrid option (Desktop or Changeable Blade Wall Plug-in) Class I or Class II input

## G) SPECIAL OPTIONS

01. Cost reduction, removal of LED
02. Custom Cordsets, various cordage types, and connector types
03. Custom Markings
04. Short term Output Surge Capability for motor loads, and other high peak current loads. Available to 120W for 1 second, and higher levels possible for limited input voltage range, or allowed voltage dip.
05. Reduced Leakage Current versions
06. Tightened output voltage tolerance
07. Reduced output ripple level
08. Reduced output power rating marking
09. High Rel PCB laminate with Plated through Holes for IPC610 Class 2 Compliance
10. Low Temperature operation, down to -40°C
11. Special Housing Colors and Cordset Colors
12. Back EMF applications, custom solutions. For unusual motor load aps and other high inductance reverse energy flow requirements
13. Improved Ingress Protection Rating

## H) OUTPUT CONNECTORS

Several output connector options are available with various output current ratings.  
GlobTek can supply 10A rated 2.1mm and 2.5mm style DC Power Jacks, to complement our 10A output rated 2.1mm and 2.5mm DC power plugs used on our output cordsets.  
Please visit <https://en.globtek.com/news/high-current-coaxial-barrel-plug-jacks-for-high-wattage-power-supplies> for a real time product offering of mating connectors.

Delivering leading edge, innovative power solutions for more than 30 years....

Model:GTM96600-65VV.V-R2L

August 17, 2019

DERATING CURVE

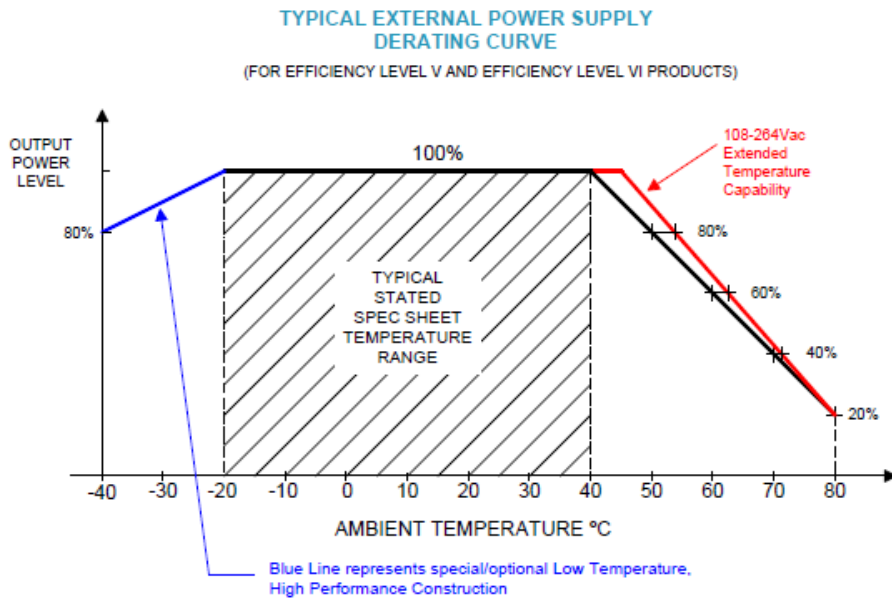

+74C operation with an output power of 19.2W; and cold start at -40C

Delivering leading edge, innovative power solutions for more than 30 years....

Model:GTM96600-65VV.V-R2L

August 17, 2019

## Input Configuration

Description IEC 60320/C8 AC Inlet connector

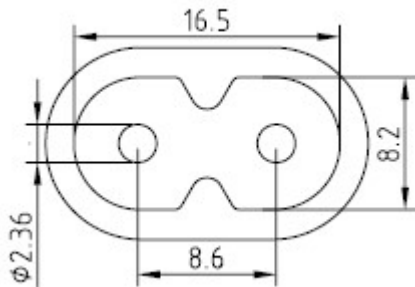
[Blade Insertion Instructions](#)
[R-Blade Style Instruction Video](#)

Mates with IEC 60320/C8 Plug

This series of Interchangeable Blade products may be used with Proprietary Interchangeable Blades as described below or with standard international power cords.

Optional INPUT BLADES: R-Socket: below are available blades configurations which are "not included" (unless stated above); may be purchased separately, packaged with power supply, or as a separate "R-KIT" if specified

1. Class II model NEMA 1-15P AC power plug with 2 prongs, R-NA-2(R)
2. Australian AS 3112 configuration: SAA 2 pins Class II, R-SAA-2(R)
3. UK BS 1363 configuration: UK 2 pins (dummy Ground) Class II, R-UK-2(R)
4. European CEE 7/16 configuration: Europlug 2 PINS, Class II, R-EU-2(R)
5. China GB 2099 configuration: 2 blades, Class II; CN P/N:R-CN-2(R)
6. Desktop Insert

Kits

05. R-KIT: 1,2,3,4 above

06. R-KIT-INTL: 2,3,4 above

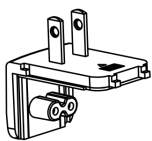

### UL 2P

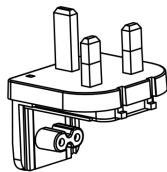
 P/N: R-NA-2(R)  
 NORTH AMERICA  
 JAPAN

### UK 2P

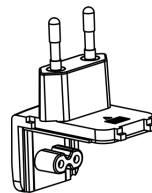
 P/N: R-UK-2(R)  
 UNITED KINGDOM  
 HONG KONG  
 SINGAPORE

### EU 2P

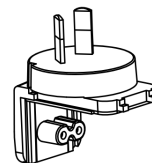
 P/N: R-EU-2(R)  
 EUROPE  
 SOUTH AMERICA

### AUS 2P

 P/N: R-SAA-2(R)  
 AUSTRALIA

Standard Cordsets

Below are standard cordsets which are "not included" (unless stated above); these may be purchased separately or packaged with the pow



Delivering leading edge, innovative power solutions for more than **30** years....

Model:GTM96600-65VV.V-R2L

August 17, 2019

supply. Contact your Sales Engineer if the style required is not shown below. Many more available in different lengths, colors or cable material.

[Standard International IEC 320/C7 Cordsets](#)

Part Number	Country	Plug	Connector	Length (mm)	Length (feet)
<u><a href="#">2094112M703(R)</a></u>	Argentina (Type I)	IRAM 2063	IEC 320/C7	2000	7
<u><a href="#">5014112M703A(R)</a></u>	Australian (Type I)	AS 3112	IEC 320/C7	2000	7
<u><a href="#">207B4111M8703(R)</a></u>	Brazil (Type N)	NBR14136	IEC 320/C7	1800	6
<u><a href="#">4533501M8703(R)</a></u>	China (Type A)	GB 2099.1	IEC 320/C7	1830	6
<u><a href="#">2074112M703A(R)</a></u>	European (Type C)	CEE 7/16	IEC 320/C7	2000	7
<u><a href="#">2084111M8703(R)</a></u>	India (Type M)	BS 546	IEC 320/C7	1800	6
<u><a href="#">451J3401M8703(R)</a></u>	Japan (Type A)	JIS 8303	IEC 320/C7	1830	6
<u><a href="#">2044112M703A(R)</a></u>	Korea (Type C)	KS C8305	IEC 320/C7	2000	7
<u><a href="#">4511116F703A(R)</a></u>	N. American (Type A)	NEMA 1-15P	IEC 320/C7	1830	6
<u><a href="#">4033401M8703A(R)</a></u>	Taiwan (Type A)	CNS690	IEC 320/C7	1830	6
<u><a href="#">6104112M703A(R)</a></u>	UK, Hong Kong, Singapore, Gulf States (Type G)	BS1363	IEC 320/C7	2000	7

Delivering leading edge, innovative power solutions for more than 30 years....

Model:GTM96600-65VV.V-R2L

August 17, 2019

**Output Configuration**

Common output connector options:

 L Type (Coaxial  
5.5x2.5mm plug)

 C Type (Coaxial  
5.5x2.1mm plug)

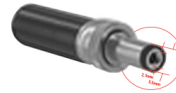
 K Type (Coaxial  
3.5x1.3mm plug)

 LL Type (5.5x2.5mm  
Locking 760k type)

 CL Type (5.5x2.1mm  
Locking S761k type)

 ML2 Type (Molex  
housing 43025-0200)

YL3 Type (KPPX-3P)



YL4 Type (KPPX-4P)

 EJ1/2/3/4/5 (EIAJ  
RC-5320A type  
connectors)

MSB Type (Micro USB)

 USBC Type (USB Type  
C)

 Inquire for custom  
design

 For a comprehensive list of options, [click here](#)











Contact GlobTek for your specific requirements or custom solutions.

Delivering leading edge, innovative power solutions for more than 30 years....

Model:GTM96600-65VV.V-R2L

August 17, 2019





## Approvals

Logo	Description
No Logo Applicable	CB for IEC 60601-1:2005+A1
No Logo Applicable	CB for IEC 62368-1:2014 (Second Edition)
	Test standard: EN 55032:2012+AC:2013 EN 61000-3-2:2014 EN 61000-3-3:2013 EN 55024:2010 EN 60601-1-2:2015
	CHINA SJ/T 11364-2014, China RoHS Chart: <a href="http://en.globtek.com/globtek-rohs.php">http://en.globtek.com/globtek-rohs.php</a>
	Declaration ДС № EAЭC N RU Д-US.KA01.B.10453_19 Custom Union of Russia, Belarus and Kazakhstan <a href="http://www.globtek.com/redirect/?loc=gost-certificate-eac-declaration">http://www.globtek.com/redirect/?loc=gost-certificate-eac-declaration</a>
	Medical Electrical Equipment - Part 1: General Requirements For Basic Safety And Essential Performance [AAMI ES60601-1:2005 +A1]
	Compliance of this power supply with FCC Part 15, Class B has been demonstrated with a standard output load. The FCC law stipulates that system-level testing is required to demonstrate compliance with the FCC emission limits with the actual system load.
	Indoor Use Only - Mark is on the label or Molded in the case
	JAPAN TUV R-PSE, Cert. No. JD 50313287, to J60950-1(H26) , J55022(H22),J3000(H25)[15V or less]. Please reference the following website for guidelines on PSE regulations: <a href="http://en.globtek.com/importing-ite-and-medical-power-supplies-ac-adaptors-to-japan/">http://en.globtek.com/importing-ite-and-medical-power-supplies-ac-adaptors-to-japan/</a>
	JAPAN TUV R-PSE, Cert. No. JD 50313287, to J60950-1(H26) , J55022(H22),J3000(H25)[DC15?30V]. Please reference the following website for guidelines on PSE regulations: <a href="http://en.globtek.com/importing-ite-and-medical-power-supplies-ac-adaptors-to-japan/">http://en.globtek.com/importing-ite-and-medical-power-supplies-ac-adaptors-to-japan/</a>
	JAPAN TUV R-PSE, Cert. No. JD 50313287, to J60950-1(H26) , J55022(H22),J3000(H25)[DC30?60V]. Please reference the following website for guidelines on PSE regulations: <a href="http://en.globtek.com/importing-ite-and-medical-power-supplies-ac-adaptors-to-japan/">http://en.globtek.com/importing-ite-and-medical-power-supplies-ac-adaptors-to-japan/</a>
<b>EFFICIENCY LEVEL VI</b> 	Efficiency: complies to section 301 of Energy Independence and Security Act (EISA) complies with Energy Star tier 2 (North America), ECP tier 2 (China), MEPS tier 2 (Australia), Code of Conduct (Europe)
	Specifications of directive 2011/65/EU Annex VI (ROHS-2) with amendment 2015/863-EU (ROHS-3)

Delivering leading edge, innovative power solutions for more than **30** years....

Model:GTM96600-65VV.V-R2L

August 17, 2019

RoHS	<a href="http://www.ce-mark.com/Rohs%20final.pdf">http://www.ce-mark.com/Rohs%20final.pdf</a>
	S-Mark Certificate EN 60601-1:2006+A1+A12, EN 60601-1-11:2015
 10276	Ukraine UKRSepro (Document: <a href="http://www.globtek.com/html/iso_certificates/GT_Ukraine.pdf">www.globtek.com/html/iso_certificates/GT_Ukraine.pdf</a> )
	Japan: Voluntary Control Council for Interference (VCCI)
	WEEE: Complies with EU 2012/19/EU ( <a href="http://ec.europa.eu/environment/waste/weee/index_en.htm">http://ec.europa.eu/environment/waste/weee/index_en.htm</a> ) Mark is on the label or Molded in the case