

Delivering leading edge, innovative power solutions for more than 30 years....

Model:GTM46402-40VV-x.x-Q

June 24, 2019

GTM46402-40VV-x.x-Q

Information

Model Number GTM46402-40VV-x.x-Q

Description

GTM46402-40VV-x.x-Q, Medical/ITE/Household use Power Supply, 60601-1-4th Ed. , Wall Plug-in, Regulated Switchmode AC-DC Power Supply AC Adaptor, , Input Rating: 100-240V~, 50-60 Hz, Blade Options for Q Series Wall Plug-in Power Supplies, Output Rating: 40 Watts, Power rating with convection cooling (W) , 5-48V in 0.1V increments, Approvals: cETLus; cETLus; UL 1310; PSE; RCM; cETLus 60601-1 3rd; CB 60335; CB 60950; cETLus 60950; CB 60601-1; Fuse 60335; Fuse 60335; cETLus UL1310; UL 1310; SELV; CB 62368; EAC; LPS; 2MOOPP; Singapore (24V); CCC; PSE; PSE; CE; Ukraine; VCCI; RoHS; Level VI; FCC; CAN ICES-3; IP52; Double Insulation; WEEE;

Model Picture



Agency

Documents

<http://www.globtek.info/certs/GTM46402/>

CE

EC-Declaration

https://www.globtek.com/pdf/ec_declaration/a0Oa000000FivPcEAJ

RoHS/RoHS2

Declaration

https://www.globtek.com/pdf/rohs_cert/a0Oa000000FivPcEAJ

REACH

Declaration

https://www.globtek.com/pdf/iso_certificates/REACH.pdf

Conflict

Minerals

Declaration

<https://www.globtek.com/pdf/conflict-minerals.pdf>

Delivering leading edge, innovative power solutions for more than **30** years....

Model:GTM46402-40VV-x.x-Q

June 24, 2019

Model Parameters

Type	Wall Plug-in
Technology	Regulated Switchmode AC-DC Power Supply AC Adaptor
Category	Medical/ITE/Household use Power Supply
Input Voltage	100-240V~, 50-60 Hz
I/P Amps (A)	1.0A
Wattage (W)	40.0
Vout Range (V)	5-48
Efficiency Level	VI
Ingress Protection	Indoor Use
Size (mm)	43.5 x 74.0 x 35.3

Delivering leading edge, innovative power solutions for more than **30** years....

Model:GTM46402-40VV-x.x-Q

June 24, 2019

ENCLOSURE

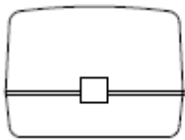
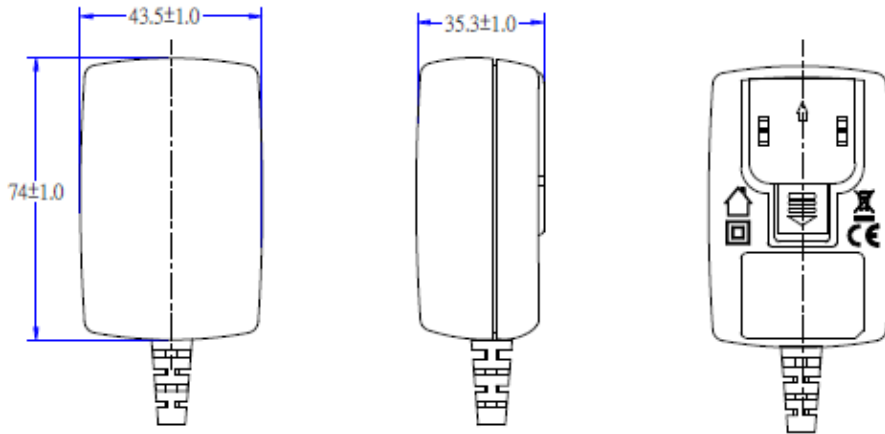

Delivering leading edge, innovative power solutions for more than **30** years....

Model:GTM46402-40VV-x.x-Q

June 24, 2019

RATING TABLE

Model Number	Voltage	Amps(A)	Watts(W)	RFQ
GTM46402-3005	5 V	6	30.00	RFQ
GTM46402-3606	6 V	6	36.00	RFQ
GTM46402-3007	5.75 V	4	30.00	RFQ
GTM46402-3509	9 V	3.88	34.92	RFQ
GTM46402-3612	12 V	3	36.00	RFQ
GTM46402-3713	4.13 V	2.76	36.98	RFQ
GTM46402-3713	6.13 V	2.72	36.99	RFQ
GTM46402-3713	8.13 V	2.68	36.98	RFQ
GTM46402-4015	15 V	2.66	39.90	RFQ
GTM46402-4018	18 V	2.2	39.60	RFQ
GTM46402-4019	19 V	2.1	39.90	RFQ
GTM46402-4024	24 V	1.66	39.84	RFQ
GTM46402-4048	48 V	0.833	39.98	RFQ

Delivering leading edge, innovative power solutions for more than 30 years....

Model:GTM46402-40VV-x.x-Q

June 24, 2019

SPECIFICATIONS**A) ELECTRICAL SPECIFICATIONS:**

01. Input Voltage: Specified 90-264 Vac, Nameplate rated: 100-240Vac
 - 90-264 Vac range @ 100% of rated load current
 - 85-264 Vac range @ 85% of rated load current
 - 110-370 VDC range @ 100% of rated load current
02. Input Frequency: Specified 47-63 Hz, Nameplate rated 50-60Hz
03. Output Regulation: +/- 5% measured at the output connector
04. Line Voltage Regulation: +/- 0.5% typical measured at full load
05. Output Ripple (Vp-p): 1% or 100 mV whichever is greater, measured at 20 MHz bandwidth with 0.1 uf ceramic capacitor in parallel with a low impedance 47 uf electrolytic capacitor connected at the end of the output connector
06. Turn-ON/OFF Overshoot: 5% maximum, 1 mS typical recovery time for 40% to 70% step load
07. Turn-ON Delay: 1 second maximum @ full load, nominal line
08. Hold-Up Time: 8 mS typical @ nominal input voltage and full load
09. Inrush Current: 30A/60A maximum cold start @ 115/230Vac input
10. Efficiency: Compliant with Efficiency Level VI and CoC Tier 2 standards
11. No Load Standby Power: <0.075 W @ 230Vac

B) PROTECTION

01. Input Protection: Input line fusing and 300Vac MOV
02. Short Circuit/ Overload: Electronically Protected unit will auto recover upon removal of fault
 - Output Current Limit: 110% to 160% of rated output current
 - (upper end of current limit range is determined by normal output power rating, not derated output power level)
03. Output Over-Voltage: 110% to 130% of nominal output voltage

C) SAFETY

01. Dielectric Withstand Voltage: 4000Vac or 5656Vdc from input to output
02. Earth Leakage Current: N/A for Class II models
03. Touch Current: < 95uA
04. Means of Protection for Medical Standard: 2 x MOPP
05. Compliant Standards: See listings at end of this drawing for specifics

D) EMC

01. Emissions, per EN 55032, EN 61000-6-3, EN 61000-6-4
 - Conducted Emissions: Class B, FCC Part 15, Class B
 - Radiated Emissions: Class B, FCC Part 15, Class B
02. Line Frequency Harmonics EN61000-3-2, Class A
03. Voltage Fluctuations/Flicker EN61000-3-3
04. Immunity, per EN 55024, EN 61000-6-1, EN 61000-6-2
 - Static Discharge Immunity EN61000-4-2, 8kV Contact Discharge, 15kV air discharge
 - Radiated RF Immunity EN61000-4-3, 3V/m 80-2700MHz, 80% 1KHz AM.
 - EFT/Burst Immunity EN61000-4-4, 2kV/100kHz.
 - Line Surge Immunity EN61000-4-5, 1kV differential, 2kV common-mode
 - Conducted RF Immunity EN61000-4-6, 3Vrms, 80% 1KHz AM
 - Power Frequency Magnetic Field Immunity EN61000-4-8, NA
 - Voltage Dip Immunity EN61000-4-11, Criteria

E) OTHER:**PROPRIETARY INFORMATION**

PROPRIETARY OF GLOBTEK, INC. ANY REPRODUCTION, DISCLOSURE OR USE OF THIS DRAWING, IN WHOLE OR IN PART, IS HEREBY PROHIBITED EXCEPT AS SPECIFIED IN WRITING BY GLOBTEK, INC.

<http://en.globtek.com/datasheet/id/a00a000000FivPc>

Delivering leading edge, innovative power solutions for more than **30** years....

Model:GTM46402-40VV-x.x-Q

June 24, 2019

01. MTBF: 1,000,000 Hours @ 40°C ambient temperature, Full Load
Projected failure rate expected to be < 0.5% after 5 years, < 3 % after 10 years
02. Operating Temperature: -20°C to 40°C ambient temperature at full load, -40°C to 50°C ambient temperature with derating to 80% load
03. Operating Humidity: 0% to 95% relative humidity, non-condensing
04. Storage Temperature: -30°C to 80°C
05. Operating Altitude: 5000 Meters for IEC 62368-1 and IEC 60335-1. 3000M for IEC 60601-1
06. Ingress Protection: IP40 standard, IP52 available as special option
07. ROHS: Compliant with latest regulations, see approvals section below

F) ENCLOSURE

01. Housing: High impact plastic, 94V0 polycarbonate, non-vented
02. Markings: Label or Laser Printed
03. AC Input mechanical: Replaceable, Class II Wall Plug-in attachments

G) SPECIAL OPTIONS

02. Custom Cordsets, various cordage types, and connector types*
03. Custom Markings
06. Tightened output voltage tolerance
07. Reduced output ripple level
08. Reduced output power rating marking
09. High Rel PCB laminate with Plated through Holes for IPC610 Class 2 Compliance
10. Special Housing Colors and Cordset Colors

Delivering leading edge, innovative power solutions for more than **30** years....

Model:GTM46402-40VV-x.x-Q

June 24, 2019

DERATING CURVE

**Typical External
Power Supply Derating Curve**

(For Efficiency Level V and Efficiency Level VI Products)

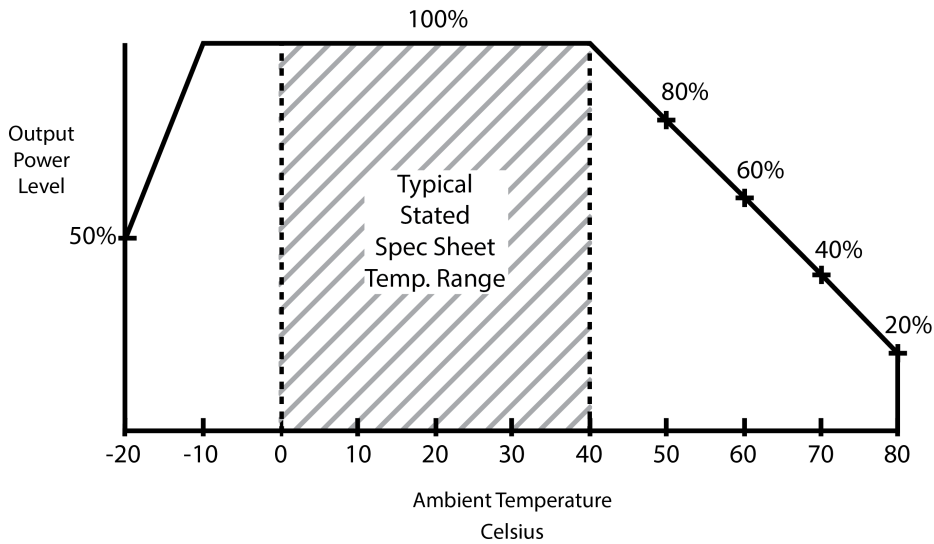

Delivering leading edge, innovative power solutions for more than 30 years....

Model:GTM46402-40VV-x.x-Q

June 24, 2019

Input Configuration

Description Blade Options for Q Series Wall Plug-in Power Supplies

 Data Sheet: <http://en.globtek.com/interchangeable-blades.php>

 Insertion Instructions: <http://www.globtek.com/pdf/Instructions-Interchangeable-Blades.pdf>

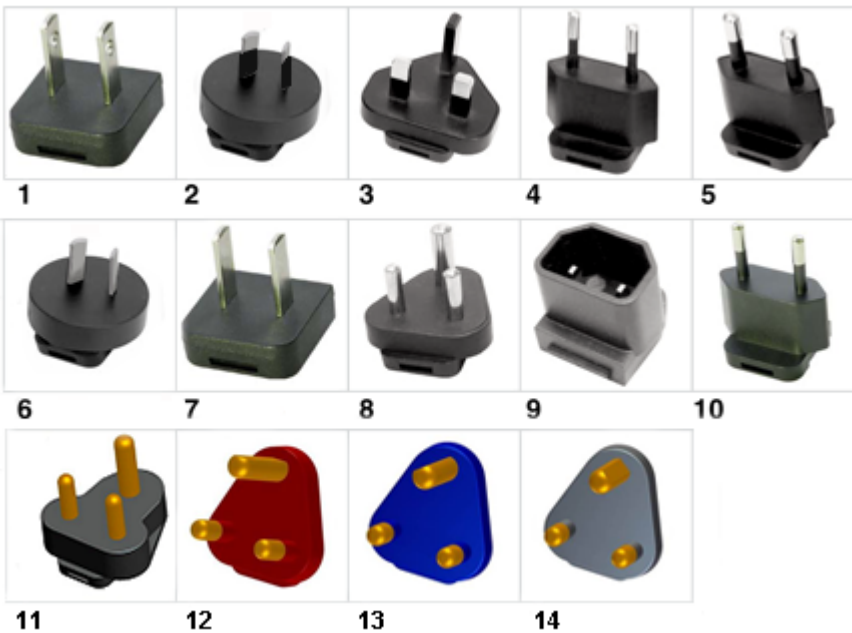
 Video: [Q-Blade Style Instruction Video](#)

INPUT CONNECTOR: Q-Socket (below are available blades configurations which are "not included" (unless stated above); can be purchased separately, package with power supply or as a separate "Q-KIT" if specified

- 01. United States / Canada / Japan NEMA 1-15P/IEC PLUG A [WORKS IN PLUG B] configuration: NA 2 blades, Class II; US/CA/JP P/N: Q-NA(R)
- 02. Australian AS 3112 configuration: SAA 2 blade/IEC TYPE I, Class II; AU P/N: Q-SAA(R)
- 03. UK BS 1363 configuration: UK 3 blade with dummy Ground/IEC TYPE G, Class II; GB P/N: Q-UK(R)
- 04. European CEE 7/16 configuration: Europlug 2 pins/IEC TYPE C [WORKS IN TYPE E&F], Class II; EU P/N: Q-EU(R)
- 05. Korean KS C8305 configuration: 2 pins/SIMILAR TO IEC TYPE C, Class II; KR P/N: Q-KR(R)
- 06. Argentina IRAM 2073 configuration: 2 blades/SIMILAR TO IEC TYPE I; AR P/N: Class II Q-AR(R)
- 07. China GB 2099 configuration: 2 blades/SIMILAR TO TYPE A, Class II; CN P/N: Q-CN(R)
- 08. India IS 1293 6A/BS546 configuration: 5A, 3 pins with Dummy Ground, Class II/IEC TYPE D; IN P/N: Q-IN(R)
- 09. IEC320/C18 Inlet, Class II; P/N: Q-C18(R)
- 10. Brazilian NBR6147 configuration: 2 pins, Class II; SIMILAR TO IEC TYPE C BR P/N: Q-BR(R)
- 11. South Africa SABS164-1, 3 round prongs, Class II + dummy ground, IEC TYPE M P/N: Q-SANS164-1-16A(R)
- 12. South Africa SABS164-4, 3 round prongs with a notched prong @ 0°, Class II + dummy ground, IEC TYPE M Red, P/N: Q-SANS164-4L-16A(R)

Delivering leading edge, innovative power solutions for more than **30** years....

Model:GTM46402-40VV-x.x-Q

June 24, 2019

13. South Africa SABS164-4, 3 round prongs with a notched prong @ -53°, Class II + dummy ground, Blue, IEC TYPE M, P/N:
Q-SANS164-4C-16A(R)
14. South Africa SABS164-4, 3 round prongs with a notched prong @ +53°, Class II + dummy ground, Black, IEC TYPE M P/N:
Q-SANS164-4R-16A(R)

Kits

- 01. Q-KIT: 1,2,3,4 above
- 02. Q-KIT-INTL: 2,3,4 above
- 03. Q-KIT-6: 1,2,3,4,5,6 above
- 04. Q-KIT-7: 1,2,3,4,5,6,7 above
- 05. Q-KIT-8: 1,2,3,4,5,6,7,8 above

Delivering leading edge, innovative power solutions for more than 30 years....

Model:GTM46402-40VV-x.x-Q

June 24, 2019

Output Configuration

Common output connector options:

 L Type (Coaxial
5.5x2.5mm plug)

 C Type (Coaxial
5.5x2.1mm plug)

 K Type (Coaxial
3.5x1.3mm plug)

 LL Type (5.5x2.5mm
Locking 760k type)

 CL Type (5.5x2.1mm
Locking S761k type)

 ML2 Type (Molex
housing 43025-0200)

YL3 Type (KPPX-3P)



YL4 Type (KPPX-4P)

 EJ1/2/3/4/5 (EIAJ
RC-5320A type
connectors)

MSB Type (Micro USB)

 USBC Type (USB Type
C)

 Inquire for custom
design

 For a comprehensive list of options, [click here](#)







Contact GlobTek for your specific requirements or custom solutions.

Delivering leading edge, innovative power solutions for more than 30 years....

Model:GTM46402-40VV-x.x-Q

June 24, 2019

Approvals









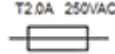

Logo	Description
2MOPP 	2 x MOPP (Means of Patient Protection) marked with 2MOPP near model name
No Logo Applicable	Book 60335 up to 36 Volts CB report IEC 60601-1: 2005 + CORR. 1 (2006) + CORR. 2 (2007) and or EN 60601-1:2006 3rd Edition
No Logo Applicable	IEC 60335-1:2010+A1+A2
No Logo Applicable	CB report to IEC 60950-1:2005 (2nd Edition) +A1:2009 + A2:2013
No Logo Applicable	CB for IEC 62368-1:2014 (Second Edition)
	CCC Altitude up to 5000 m GB17625.1-2012, GB4943.1-2011, GB/T9254-2008
	CE Mark: tested to comply with EN55022:2006/A1:2007 Class B, EN610003-2, EN610003-3 including EN61000-4-2, EN61000-4-3, EN61000-4-4, EN61000-4-5, EN61000-4-6N EN61000-4-11; EMI: Complies with EN55011 CLASS B and FCC Part 15B - On label or Molded in case
 Intertek	cETLus-Cert 4007497 UL1310 Recognized Component up to 48 volts
Class 2 Power Unit   Intertek	Medical Electrical Equipment - Part 1: General Requirements For Basic Safety And Essential Performance [AAMI ES60601-1:2005 +A1]Medical Electrical Equipment - Part 1: General Requirements For Basic Safety And Essential Performance [CSA C22.2#60601-1:2014
 Intertek 4007497	Information Technology Equipment Safety Part 1: General Requirements (UL 60950-1 Issued: 2007/03/27 Ed: 2 Rev: 2014/10/14) Information Technology Equipment Safety Part 1: General Requirements (CSA C22.2 No. 60950-1 Issued:2007/03/27 Ed: 2 (R2012) Amd. 1
Conforms to AAMI STD.ES60601-1,IEC 60601-1-11 Certified to CAN/CSA STD.C22.2 NO.60601-1 Conforms to UL STD. 1310 Certified to CSA STD. C22.2 NO.223 Conforms to UL STD. 60950-1 Certified to CSA STD C22.2 NO.60950-1	Conforms to AAMI STD.ES60601-1,IEC 60601-1-11 Certified to CAN/CSA STD.C22.2 NO.60601-1 Conforms to UL STD. 1310 Certified to CSA STD. C22.2 NO.223 Conforms to UL STD. 60950-1 Certified to CSA STD C22.2 NO.60950-1

 Declaration # EA9C N RU Д-US.АД75.B.01052 Custom Union of Russia, Belarus and Kazakhstan
<http://www.globtek.com/redirect/?loc=gost-certificate-eac-declaration>

Delivering leading edge, innovative power solutions for more than 30 years....

Model:GTM46402-40VV-x.x-Q

June 24, 2019

 	<p>Compliance of this power supply with FCC Part 15, Class B has been demonstrated with a standard output load. The FCC law stipulates that system-level testing is required to demonstrate compliance with the FCC emission limits with the actual system load.</p> <p>Fuse 60335 T2.0A 250VAC Up to 36 volts</p>
<p>CAN ICES-3(B)/NMB-3(B)</p>	<p>Compliance of this PSU with Industry Canada, Class B demonstrated with a standard output load. The ICES law stipulates that system-level testing is required to demonstrate compliance with the ICES-3 emission limits with the actual system load.</p>
 IP52	<p>Indoor Use Only - Mark is on the label or Molded in the case</p> <p>Ingress Protection: ?IP52 to IEC60529:2001 Protected against dust - limited ingress (no harmful deposit) and Protected against direct sprays up to 15 degrees from the vertical (with R-Blades)</p>
 GlobTek, Inc.	<p>JAPAN TUV R-PSE, Cert. No. JD 50313285, to J60950-1(H26) , J55022(H22),J3000(H25)[15V or less]. Please reference the following website for guidelines on PSE regulations: http://en.globtek.com/importing-ite-and-medical-power-supplies-ac-adaptors-to-japan/</p>
 GlobTek, Inc.	<p>JAPAN TUV R-PSE, Cert. No. JD 50313285, to J60950-1(H26) , J55022(H22),J3000(H25)[DC15? 30V]. Please reference the following website for guidelines on PSE regulations: http://en.globtek.com/importing-ite-and-medical-power-supplies-ac-adaptors-to-japan/</p>
 GlobTek, Inc.	<p>JAPAN TUV R-PSE, Cert. No. JD 50313285, to J60950-1(H26) , J55022(H22),J3000(H25)[DC30? 60V]. Please reference the following website for guidelines on PSE regulations: http://en.globtek.com/importing-ite-and-medical-power-supplies-ac-adaptors-to-japan/</p>
EFFICIENCY LEVEL (VI)	<p>Efficiency: complies to section 301 of Energy Independence and Security Act (EISA) complies with Energy Star tier 2 (North America), ECP tier 2 (China), MEPS tier 2 (Australia), Code of Conduct (Europe)</p>
LPS 	<p>Limited Power Source</p> <p>RCM certificate SAA-182146-EA; Australia and New Zealand Regulatory Compliance, Mark (http://rcm.standards.org.au/rcmfaq/rcmfaq.htm)</p>
RoHS	<p>Specifications of directive 2011/65/EU Annex VI (ROHS-2) with amendment 2015/863-EU (ROHS-3) http://www.ce-mark.com/Rohs%20final.pdf</p>
SELV  180574-11	<p>safety/separated extra-low voltage IEC 60950-1: 2005 (2nd Edition) and/or EN 60950-1:2006</p> <p>Singapore 180574-11 for GTM46402-4024</p>
 10276	<p>Ukraine UKRSepr (Document: www.globtek.com/html/iso_certificates/GT_Ukraine.pdf)</p>
<p>DO NOT REMOVE THE TAG WARNING/ADVERTISEMENT RISK OF ELECTRIC SHOCK DRY LOCATION USE ONLY FOR INDOOR USE ONLY Risque de choc électrique Utilisation endroit sec Pour une utilisation en intérieur See instructions if the input plug does not fit the power outlet</p>	<p>UL1310 Warning Label Up To 48 Volts with plugs</p>
 	<p>Japan: Voluntary Control Council for Interference (VCCI)</p> <p>WEEE: Complies with EU 2012/19/EU (http://ec.europa.eu/environment/waste/weee/index_en.htm) Mark is on the label or Molded in the case</p>