

Delivering leading edge, innovative power solutions for more than 30 years....

Model:GTM93021-20VV-D2 (PCB Mount/Pins) Unterputz Netzteil

May 20, 2019

GTM93021-20VV-D2 (PCB Mount/Pins) Unterputz Netzteil

Information

Model Number GTM93021-20VV-D2 (PCB Mount/Pins) Unterputz Netzteil

Description GTM93021-20VV-D2 (PCB Mount/Pins) Unterputz Netzteil, ITE / Medical Power Supply/Class 2/Household Power Supply, Potted/Encapsulated in plastic housing, Regulated Switchmode AC-DC Power Supply AC Adaptor, , Input Rating: 100-240V~, 50-60 Hz, Solder Pins for Line & Neutral, 1.4 mm square pins, 4.5 mm long, Output Rating: 20 Watts, Power rating with convection cooling (W) , 5-48V in 0.1V increments, Approvals: Fuse 60335; CB EN/IEC 60335-1; CE; Double Insulation; GOST-R; NEMKO EN/IEC 60335-1; PSE; RoHS; China RoHS; S-Mark 61558; Ukraine; WEEE; VCCI; cETLus; IEC 61558-1; CB 61558-2-16; UL 1310; UL 1310; cETLus UL1310; Fuse 60335; IP68;

Model Picture



Agency

Documents <http://www.globtek.info/certs/GTM93021>

CE

EC-Declaration https://www.globtek.com/pdf/ec_declaration/a0Oa000000C2jGeEAJ

RoHS/RoHS2

Declaration https://www.globtek.com/pdf/rohs_cert/a0Oa000000C2jGeEAJ

REACH

Declaration https://www.globtek.com/pdf/iso_certificates/REACH.pdf

Conflict

Minerals

Declaration <https://www.globtek.com/pdf/conflict-minerals.pdf>

Delivering leading edge, innovative power solutions for more than **30** years....

Model:GTM93021-20VV-D2 (PCB Mount/Pins) Unterputz Netzteil

May 20, 2019

Model Parameters

Type	Potted/Encapsulated in plastic housing
Technology	Regulated Switchmode AC-DC Power Supply AC Adaptor
Category	ITE / Medical Power Supply/Class 2/Household Power Supply
Input Voltage	100-240V~, 50-60 Hz
I/P Amps (A)	0.6
Wattage (W)	20.0
Vout Range (V)	5-48
Efficiency Level	V
Ingress Protection	IP68
Size (mm)	48*51*35

Delivering leading edge, innovative power solutions for more than 30 years....

Model:GTM93021-20VV-D2 (PCB Mount/Pins) Unterputz Netzteil

May 20, 2019

ENCLOSURE

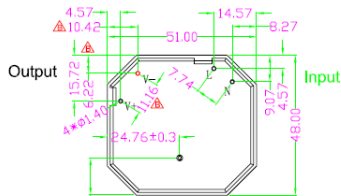

Plastic spacer support
Kang Yang Part NO:
GSS-4.8

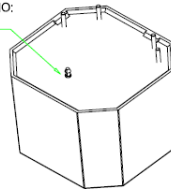

For match the thickness of PCB

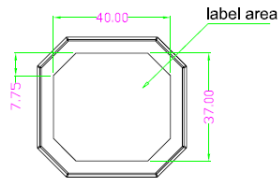
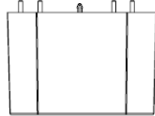
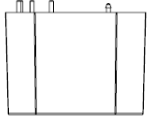
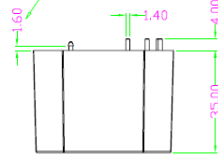

Nylon Stability Pin Detail:

MATERIAL: NYLON 66 (UL)

FLAME CLASS: 94V-2

P.C.B Ø2.5

THICKNESS 1.6

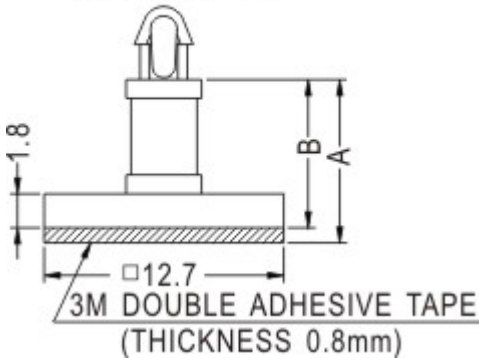

Delivering leading edge, innovative power solutions for more than **30** years....

Model:GTM93021-20VV-D2 (PCB Mount/Pins) Unterputz Netzteil

May 20, 2019

RATING TABLE

Model Number	Voltage	Amps(A)	Watts(W)	RFQ
GTM93021-1507-2.0-D2	25 V	3	15.00	RFQ
GTM93021-1809-D2	9 V	2	18.00	RFQ
GTM93021-2009-D2	9 V	2.22	19.98	RFQ
GTM93021-2015-3.0-D2	12 V	1.67	20.04	RFQ
GTM93021-2024-D2	24 V	0.83	19.92	RFQ
GTM93021-2036-D2	36 V	0.56	20.16	RFQ
GTM93021-2048-D2	48 V	0.42	20.16	RFQ

Delivering leading edge, innovative power solutions for more than 30 years....

Model:GTM93021-20VV-D2 (PCB Mount/Pins) Unterputz Netzteil

May 20, 2019

SPECIFICATIONS**A) ELECTRICAL SPECIFICATIONS:**

01. Input Voltage: Specified 90-264 Vac, Nameplate rated: 100-240Vac
02. Input Frequency: Specified 47-63 Hz, Nameplate rated 50-60Hz
03. Output Regulation: +/- 5% measured at the output connector
04. Line Voltage Regulation: +/- 1% typical measured at full load
05. Output Ripple (Vp-p): +/-1% or 150 mV whichever is greater, measured at 20 MHz bandwidth with 0.1 uf ceramic capacitor in parallel with 10 uf electrolytic capacitor connected at the end of the output connector at nominal line
06. Turn-ON/OFF Overshoot: 5% maximum, 1 mS typical recovery time for 25% to 50% step load
07. Turn-ON Delay: 3000 mS, maximum @ full load, nominal line
08. Hold-Up Time: 8 mS typical @ nominal input voltage and full load
09. Inrush Current: 30A maximum cold start @ 240Vac input
10. Switching Frequency: 65 KHz typical

B) PROTECTION

01. Over-Voltage: Electronically Protected Zener clamp across the output
02. Short Circuit: Electronically Protected unit will auto recover upon removal of fault
04. Input Protection: Input line and neutral fusing

C) SAFETY

01. Dielectric Withstand Voltage: 4242Vdc from primary to secondary
02. Earth Leakage Current: <0.25 mA at 240Vac input voltage
03. Earth continuity test:<0.1 Ohm or < 0.2 Ohm when with a non-detachable Power Supply cord, Class I Only
04. ROHS 2: Complies with EU 2011/65/EU and China SJ/T 11363-2006

D) OTHER:

01. MTBF: 200,000 Hours @ 25°C ambient temperature
02. Operating Temperature: 0°C to 40°C ambient temperature
03. Humidity: 0% to 90% relative humidity
04. Storage Temperature: -10°C to 80°C
05. Cooling: Convection

E) ENCLOSURE

01. Housing: High impact plastic, 94V0 polycarbonate, non-vented
02. Size: 48.0 Length x 51.0 Width x 35.0 High mm +/-1.0 mm typical Unterputz Power Supply (netzteil) for "Hohlwanddose" per VDE0606 (Einbau-Netzteil Stromversorgung für Unterputz-Installation)
03. Markings: Label and/or Pad Printed and/or Molded in the case

Delivering leading edge, innovative power solutions for more than **30** years....

Model:GTM93021-20VV-D2 (PCB Mount/Pins) Unterputz Netzteil

May 20, 2019

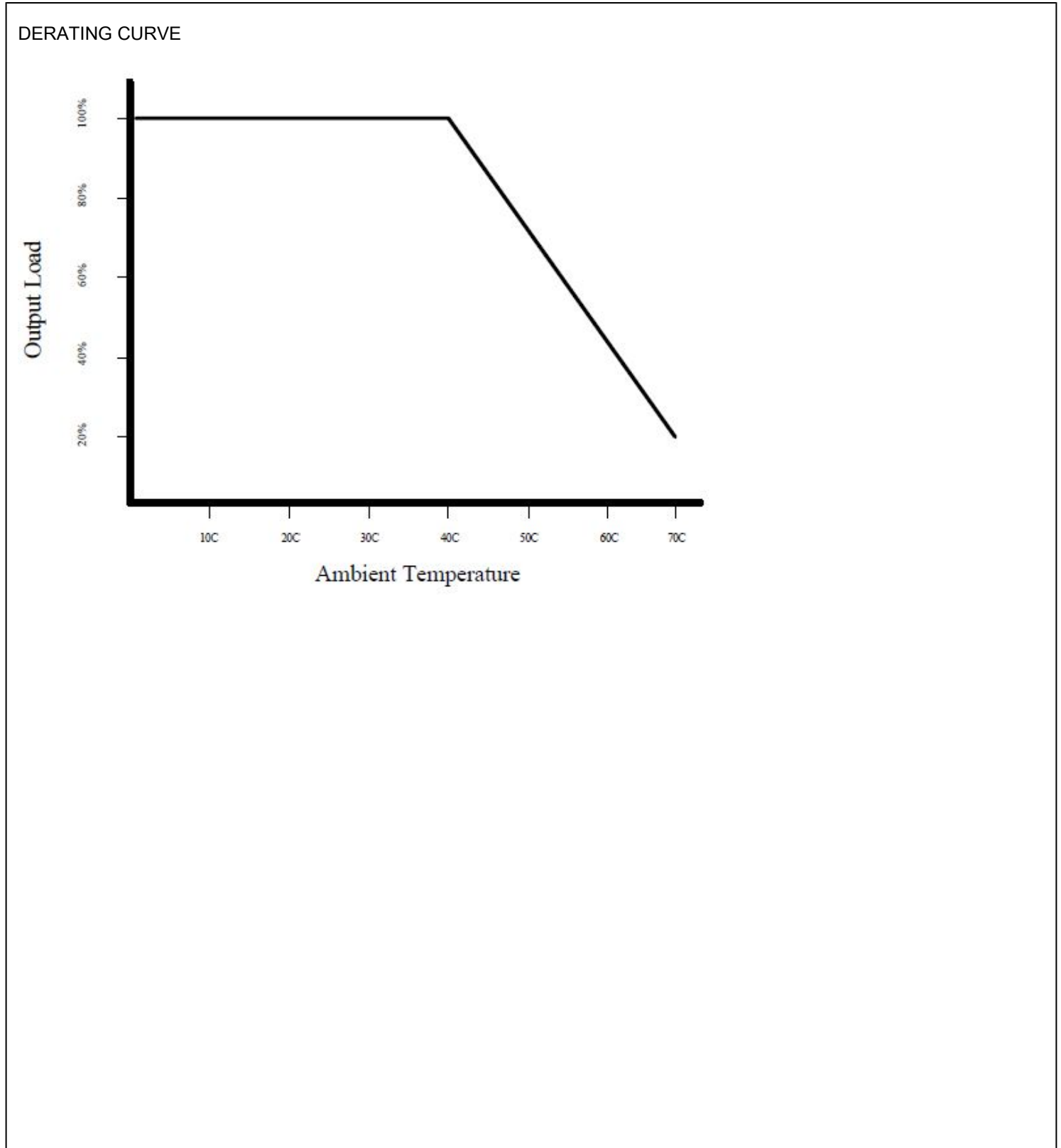

Delivering leading edge, innovative power solutions for more than **30** years....

Model:GTM93021-20VV-D2 (PCB Mount/Pins) Unterputz Netzteil

May 20, 2019

Input Configuration

Description Solder Pins for Line & Neutral, 1.4 mm square pins, 4.5 mm long

Delivering leading edge, innovative power solutions for more than 30 years....

Model:GTM93021-20VV-D2 (PCB Mount/Pins) Unterputz Netzteil

May 20, 2019

Output Configuration

Common output connector options:

 L Type (Coaxial
5.5x2.5mm plug)

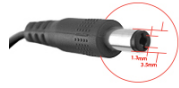
 C Type (Coaxial
5.5x2.1mm plug)

 K Type (Coaxial
3.5x1.3mm plug)

 LL Type (5.5x2.5mm
Locking 760k type)

 CL Type (5.5x2.1mm
Locking S761k type)

 ML2 Type (Molex
housing 43025-0200)

YL3 Type (KPPX-3P)



YL4 Type (KPPX-4P)

 EJ1/2/3/4/5 (EIAJ
RC-5320A type
connectors)

MSB Type (Micro USB)

 USBC Type (USB Type
C)

 Inquire for custom
design

 For a comprehensive list of options, [click here](#)











Contact GlobTek for your specific requirements or custom solutions.

Delivering leading edge, innovative power solutions for more than 30 years....

Model:GTM93021-20VV-D2 (PCB Mount/Pins) Unterputz Netzteil

May 20, 2019







Approvals

Logo	Description
	Book 60335 up to 36 Volts
No Logo Applicable	CB to 60335-1 5th Edition (Safety of Household and Similar Electrical Appliances, Part 1: General Requirements) CB Report/ Certificate IEC 60335-1:2010 Up to 36 volts only
No Logo Applicable	CB report to IEC 61558-2-16_2009 1st Edition IEC 61558-1_2005 2nd Edition + A1_2009 EN 61558-1-16_2009 EN 61558-1_2005 + A1_2009.pdf
 <small>Conforms to UL std 1310 Cert.to CSA Std. C22.2 NO.223</small>	CE Certification cETLus UL std 1310 Up to 36 volts
 Intertek	cETLus-Cert 4007497 UL1310 Recognized Component up to 36 volts
Class 2 Power Unit	
	CHINA SJ/T 11364-2014, China RoHS Chart: http://en.globtek.com/globtek-rohs.php
T1.6A 250VAC 	Fuse 60335 T1.6A 250VAC Up to 36 volts
	GOST-R mark for Russia(Document: http://www.globtek.com/html/iso_certificates/GT_GOST-R.pdf). 03/15/2015. Due to lack of demand, GlobTek will not be renewing it's GOST certification. Please contact your sales engineer for pricing on EAC.
Ta:50°C 	IEC 61558-1 GTM93021 Maximum Ambient Temperature, Max 50°C Indoor Use Only - Mark is on the label or Molded in the case
IP68	Ingress Protection: ?IP68 to IEC60529:2001 Totally dust tight and Protected against long periods of immersion under pressure
 IEC/EN60335-1	NEMKO IEC/EN 60335-1 (Safety of Household and Similar Electrical Appliances, Part 1: General Requirements) up to 36 Volts
 GlobTek, Inc.	JAPAN TUV Rheinland-PSE GlobTek Inc to J60950-1(H26) , J55022(H22),J3000(H25).Please follow the procedure listed in the following link for proper import to Japan: http://en.globtek.com/importing-to-japan.php .
RoHS	Specifications of directive 2011/65/EU Annex VI (ROHS-2) with amendment 2015/863-EU (ROHS-3) http://www.ce-mark.com/Rohs%20final.pdf
 Intertek IEC/EN61558-1	S-Mark-Cert-IEC_EN61558-1 (http://www.intertek.com/marks/s/)
	Transformer Symbol IEC 61558-1 SMPS Short-Circuit –Proof Safety Isolating Transformer

Delivering leading edge, innovative power solutions for more than **30** years....

Model:GTM93021-20VV-D2 (PCB Mount/Pins) Unterputz Netzteil

May 20, 2019

	Transformer Symbol IEC 61558-1 SMPS Switch Mode Power supply
 10276	Ukraine UKRSepró (Document: www.globtek.com/html/iso_certificates/GT_Ukraine.pdf)
 WARNING RISK OF ELECTRIC SHOCK DRY LOCATION USE ONLY FOR INDOOR USE ONLY See instructions if the input plug does not fit the power outlet	UL1310 Warning Label Up To 36 Volts For GTM93021 Only 1 of 2
 AVERTISSEMENT Risque de choc électrique Utilisation endroit sec Pour une utilisation en intérieur	UL1310 Warning Label Up To 36 Volts For GTM93021 Only 2 of 2
	Japan: Voluntary Control Council for Interference (VCCI)
	WEEE: Complies with EU 2012/19/EU (http://ec.europa.eu/environment/waste/weee/index_en.htm) Mark is on the label or Molded in the case