

Delivering leading edge, innovative power solutions for more than **30** years....

Model:GT-41134-06VV-x.x-W2E

June 24, 2019

## GT-41134-06VV-x.x-W2E

### Information

Model Number GT-41134-06VV-x.x-W2E

Description GT-41134-06VV-x.x-W2E, ITE Power Supply, 60601-1-4th Ed. , Wall Plug-in, Regulated Switchmode AC-DC Power Supply AC Adaptor, , Input Rating: 100-240V~, 50-60 Hz, European CEE 7/16 configuration: Europlug 2 PIN, Output Rating: 6 Watts, Power rating with convection cooling (W) , 3.3-24V in 0.1V increments, Approvals: RCM; CE; Level V; Ukraine; Double Insulation; WEEE; CB 60950; UL/cUL; RoHS; China RoHS; EAC; PSE;

Model Picture



Agency Documents  
CE <http://www.globtek.info/certs/GT-41134-W2Z%20Fixed%20Blades/>  
EC-Declaration [https://www.globtek.com/pdf/ec\\_declaration/a0Oa000000BzyF1EAJ](https://www.globtek.com/pdf/ec_declaration/a0Oa000000BzyF1EAJ)  
RoHS/RoHS2 Declaration [https://www.globtek.com/pdf/rohs\\_cert/a0Oa000000BzyF1EAJ](https://www.globtek.com/pdf/rohs_cert/a0Oa000000BzyF1EAJ)  
REACH Declaration [https://www.globtek.com/pdf/iso\\_certificates/REACH.pdf](https://www.globtek.com/pdf/iso_certificates/REACH.pdf)  
Conflict Minerals Declaration <https://www.globtek.com/pdf/conflict-minerals.pdf>

Delivering leading edge, innovative power solutions for more than **30** years....

Model:GT-41134-06VV-x.x-W2E

June 24, 2019

**Model Parameters**

Type	Wall Plug-in
Technology	Regulated Switchmode AC-DC Power Supply AC Adaptor
Category	ITE Power Supply
Input Voltage	100-240V~, 50-60 Hz
I/P Amps (A)	0.3A
Wattage (W)	6.0
Vout Range (V)	3.3-24
Efficiency Level	V
Ingress Protection	
Size (mm)	41*62*32

Delivering leading edge, innovative power solutions for more than **30** years....

Model:GT-41134-06VV-x.x-W2E

June 24, 2019

ENCLOSURE

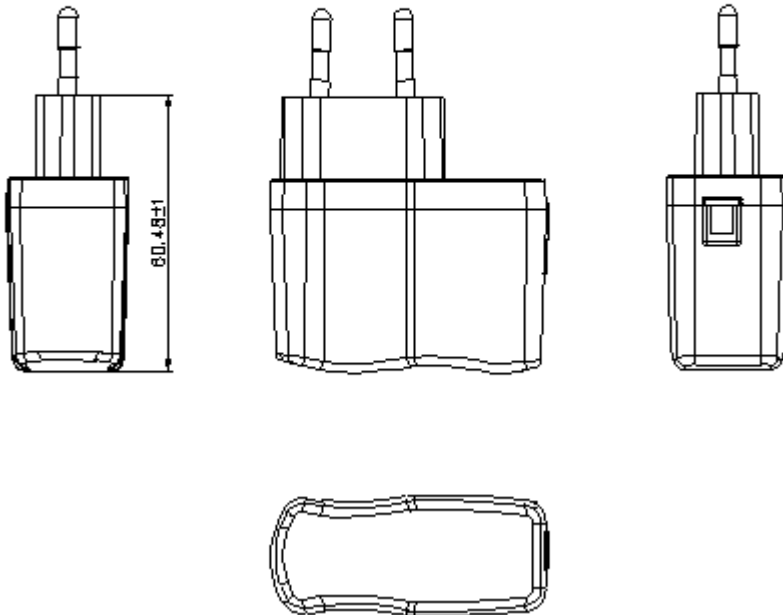
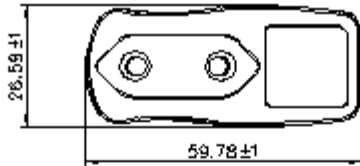

Delivering leading edge, innovative power solutions for more than **30** years....

Model:GT-41134-06VV-x.x-W2E

June 24, 2019

**RATING TABLE**

Model Number	Voltage	Amps(A)	Watts(W)	RFQ
GT-41134-0603-W2E	3.3 V	1.8	5.94	<a href="#">RFQ</a>
GT-41134-0604-W2E	4 V	1.5	6.00	<a href="#">RFQ</a>
GT-41134-0606-1.0-W2E	5 V	1.2	6.00	<a href="#">RFQ</a>
GT-41134-0606-W2E	6 V	1	6.00	<a href="#">RFQ</a>
GT-41134-0612-3.0-W2E	9 V	0.67	6.03	<a href="#">RFQ</a>
GT-41134-0612-W2E	12 V	0.5	6.00	<a href="#">RFQ</a>
GT-41134-0615-W2E	15 V	0.4	6.00	<a href="#">RFQ</a>
GT-41134-0618-W2E	18 V	0.33	5.94	<a href="#">RFQ</a>
GT-41134-0624-W2E	24 V	0.25	6.00	<a href="#">RFQ</a>

Delivering leading edge, innovative power solutions for more than 30 years....

Model:GT-41134-06VV-x.x-W2E

June 24, 2019

## SPECIFICATIONS

### A) ELECTRICAL SPECIFICATIONS:

01. Input Voltage: Specified 90-264 Vac, Nameplate rated: 100-240Vac
02. Input Frequency: Specified 47-63 Hz, Nameplate rated 50-60Hz
03. Output Regulation: +/- 5% measured at the output connector
04. Output Regulation: +/- 5% measured at the output connector measured at the end of a 1 meter USB cordset employing #22 Gauge conductors
05. Line Voltage Regulation: +/- 1% typical measured at the output connector measured at the end of a 1 meter USB cordset employing #22 Gauge conductors
06. Output Ripple (Vp-p): +/-1% or 100 mV whichever is greater measured at the end of a 1 meter USB cordset employing #22 Gauge conductors. Measured at 20 MHz bandwidth with 0.1 uf ceramic capacitor in parallel with 10 uf electrolytic capacitor connected at the end of the output connector.
07. Turn-ON Delay: 1 Second, typical
08. Hold-Up Time: 8 mS typical at nominal input voltage and full load
09. Inrush Current: 30A typical at 115VAC input and 60A typical at 230VAC input
10. Switching Frequency: 65 KHz typical

### B) PROTECTION

01. Over-Voltage: Protected Zener clamp across the output
02. Short Circuit: Protected unit will auto recover upon removal of fault
03. Input Protection: Input line fusing

### C) SAFETY

01. Dielectric Withstand Voltage: 4242Vdc from primary to secondary
02. Touch Current: <0.25mA @ 240Vac input voltage

### D) OTHER:

01. MTBF: 200,000 Hours @ 25°C ambient temperature
02. Operating Temperature: 0°C to 40°C ambient temperature
03. Humidity: 0% to 90% relative humidity
04. Storage Temperature: -10°C to 80°C
05. Cooling: Convection

### E) ENCLOSURE

01. Housing: High impact plastic, 94V0 polycarbonate, non-vented
02. Size: 59.78 x 60.48 x 26.59mm +/- 1.0
03. Markings: Label and/or Pad Printed and/or Molded in the case

Delivering leading edge, innovative power solutions for more than **30** years....

Model:GT-41134-06VV-x.x-W2E

June 24, 2019

DERATING CURVE

Delivering leading edge, innovative power solutions for more than 30 years....

Model:GT-41134-06VV-x.x-W2E

June 24, 2019

## Input Configuration

Description European CEE 7/16 configuration: Europlug 2 PIN

The prongs of the Europlug are 19 mm long. They consist of a 9 mm long conductive tip of 4 mm diameter with a rounded ending, followed by a 10 mm long flexible insulated shaft of not more than 3.8 mm diameter. The two prongs are not exactly parallel and converge slightly; their centres are 19 mm apart at the tip and 18.6 mm apart at the base. The elasticity of the converging prongs provides sufficient contact force for the Europlug's current rating with a variety of socket-hole arrangements. The entire plug is 35.3 mm wide and 13.7 mm high, and must not exceed these dimensions within 18 mm behind its front plane (this allows for the recesses on many European socket types). The left and right side of the plug are formed by surfaces that are at 45° relative to the horizontal plan.

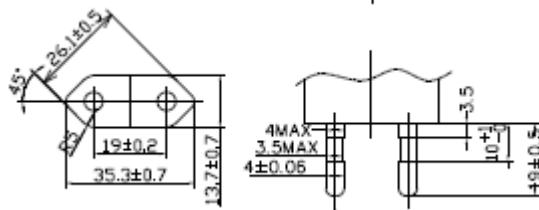

Delivering leading edge, innovative power solutions for more than 30 years....

Model:GT-41134-06VV-x.x-W2E

June 24, 2019

**Output Configuration**

Common output connector options:

 L Type (Coaxial  
5.5x2.5mm plug)

 C Type (Coaxial  
5.5x2.1mm plug)

 K Type (Coaxial  
3.5x1.3mm plug)

 LL Type (5.5x2.5mm  
Locking 760k type)

 CL Type (5.5x2.1mm  
Locking S761k type)

 ML2 Type (Molex  
housing 43025-0200)

YL3 Type (KPPX-3P)



YL4 Type (KPPX-4P)

 EJ1/2/3/4/5 (EIAJ  
RC-5320A type  
connectors)

MSB Type (Micro USB)

 USBC Type (USB Type  
C)

 Inquire for custom  
design

 For a comprehensive list of options, [click here](#)

Contact GlobTek for your specific requirements or custom solutions.













Delivering leading edge, innovative power solutions for more than 30 years....

Model:GT-41134-06VV-x.x-W2E

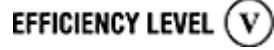
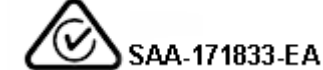
June 24, 2019

## Approvals

Logo	Description
No Logo	Applicable IEC 60950-1:2005 (Second Edition) + A1:2009 + A2:2013
	CE Certification Class II CE Mark: tested to comply with EN55022:2006/A1:2007 Class B, EN610003-2, EN610003-3 including EN61000-4-2, EN61000-4-3, EN61000-4-4, EN61000-4-5, EN61000-4-6N EN61000-4-11; EMI: Complies with EN55011 CLASS B and FCC Part 15 B
	CHINA SJ/T 11364-2014, China RoHS Chart: <a href="http://en.globtek.com/globtek-rohs.php">http://en.globtek.com/globtek-rohs.php</a>
	UL60950-1, cULus to UL 60950-1, 2nd Edition, 2007-03-27 and CSA C22.2 No. 60950-1-07, 2nd Edition, 2007-03
	Certification # TC RU AR46.B.75423 Custom Union of Russia, Belarus and Kazakhstan
	Indoor Use Only - Mark is on the label or Molded in the case
	JAPAN TUV R-PSE, Cert. No. JD 50315866, to J60950-1(H26) , J55022(H22),[15V or less]. Please reference the following website for guidelines on PSE regulations: <a href="http://en.globtek.com/importing-ite-and-medical-power-supplies-ac-adaptors-to-japan/">http://en.globtek.com/importing-ite-and-medical-power-supplies-ac-adaptors-to-japan/</a>
	Efficiency: complies to section 301 of Energy Independence and Security Act (EISA) complies with Energy Star tier 2 (North America), ECP tier 2 (China), MEPS tier 2 (Australia), Code of Conduct (Europe)
	RCM certificate SAA-171833-EA; Australia and New Zealand Regulatory Compliance, Mark ( <a href="http://rcm.standards.org.au/rcmfaq/rcmfaq.htm">http://rcm.standards.org.au/rcmfaq/rcmfaq.htm</a> )
	Specifications of directive 2011/65/EU Annex VI (ROHS-2) with amendment 2015/863-EU (ROHS-3) <a href="http://www.ce-mark.com/Rohs%20final.pdf">http://www.ce-mark.com/Rohs%20final.pdf</a>
	Ukraine UKRSepro (Document: <a href="http://www.globtek.com/html/iso_certificates/GT_Ukraine.pdf">www.globtek.com/html/iso_certificates/GT_Ukraine.pdf</a> )
	WEEE: Complies with EU 2012/19/EU ( <a href="http://ec.europa.eu/environment/waste/weee/index_en.htm">http://ec.europa.eu/environment/waste/weee/index_en.htm</a> ) Mark is on the label or Molded in the case