

Delivering leading edge, innovative power solutions for more than 30 years....

Model:GT-41134-06VV-x.x-Q

May 25, 2019

GT-41134-06VV-x.x-Q

Information

Model Number GT-41134-06VV-x.x-Q

Description GT-41134-06VV-x.x-Q, ITE Power Supply, Wall Plug-in, Regulated Switchmode AC-DC Power Supply AC Adaptor, , Input Rating: 100-240V~, 50-60 Hz, Blade Options for Q Series Wall Plug-in Power Supplies, Output Rating: 6 Watts, Power rating with convection cooling (W) , 3.3-24V in 0.1V increments, Approvals: RCM; WEEE; VCCI; CCC; RoHS; Ukraine; Double Insulation; LPS; NrCAN; EC; China RoHS; Level V; CB 60950; Korea (7.5V Only); CE; FCC; cULus; IP52; EAC; S-Mark 60950; PSE; PSE; PSE;

Model Picture



Agency Documents CE <http://www.globtek.info/certs/GT-41134%20Interchangeable/>
EC-Declaration https://www.globtek.com/pdf/ec_declaration/a0O30000007P7ZpEAK
RoHS/RoHS2 Declaration https://www.globtek.com/pdf/rohs_cert/a0O30000007P7ZpEAK
REACH Declaration https://www.globtek.com/pdf/iso_certificates/REACH.pdf
Conflict Minerals Declaration <https://www.globtek.com/pdf/conflict-minerals.pdf>

Delivering leading edge, innovative power solutions for more than **30** years....

Model:GT-41134-06VV-x.x-Q

May 25, 2019

Model Parameters

Type	Wall Plug-in
Technology	Regulated Switchmode AC-DC Power Supply AC Adaptor
Category	ITE Power Supply
Input Voltage	100-240V~, 50-60 Hz
I/P Amps (A)	0.3A
Wattage (W)	6.0
Vout Range (V)	3.3-24
Efficiency Level	V
Ingress Protection	Indoor Use
Size (mm)	41*62*32

Delivering leading edge, innovative power solutions for more than **30** years....

Model:GT-41134-06VV-x.x-Q

May 25, 2019

ENCLOSURE

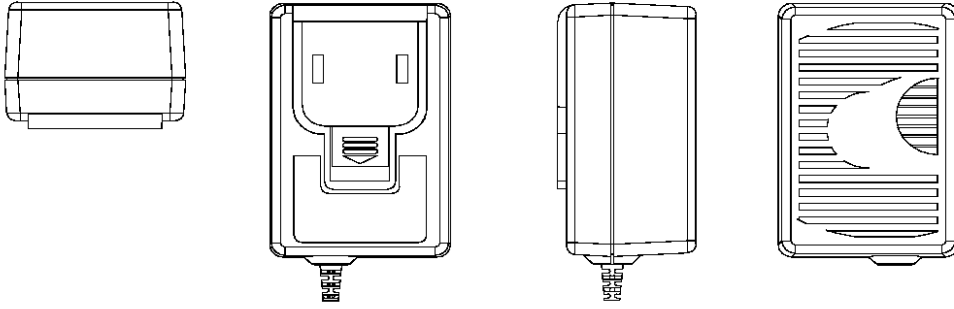

Delivering leading edge, innovative power solutions for more than **30** years....

Model:GT-41134-06VV-x.x-Q

May 25, 2019

RATING TABLE

Model Number	Voltage	Amps(A)	Watts(W)	RFQ
GT-41134-0603	3.3 V	1.8	5.94	RFQ
GT-41134-0606-2.73	3.3 V	1.2	3.96	RFQ
GT-41134-0604	4 V	1.5	6.00	RFQ
GT-41134-0606-1.05	V	1.2	6.00	RFQ
GT-41134-0606-0.55	5 V	1.09	6.00	RFQ
GT-41134-0606	6 V	1	6.00	RFQ
GT-41134-0612-5.56	5 V	0.923	6.00	RFQ
GT-41134-0612-4.57	5 V	0.8	6.00	RFQ
GT-41134-0612-3.09	V	0.67	6.03	RFQ
GT-41134-0612	12 V	0.5	6.00	RFQ
GT-41134-0615	15 V	0.4	6.00	RFQ
GT-41134-0618	18 V	0.33	5.94	RFQ
GT-41134-0624	24 V	0.25	6.00	RFQ
GT-41134-0648	48 V	0.125	6.00	RFQ

Delivering leading edge, innovative power solutions for more than 30 years....

Model:GT-41134-06VV-x.x-Q

May 25, 2019

SPECIFICATIONS

A) ELECTRICAL SPECIFICATIONS:

01. Input Voltage: Specified 90-264 Vac, Nameplate rated: 100-240Vac
02. Input Frequency: Specified 47-63 Hz, Nameplate rated 50-60Hz
03. Output Regulation: +/- 5% measured at the output connector
04. Line Voltage Regulation: +/- 1% typical measured at the output connector
05. Output Ripple (Vp-p): +/-1% or 150 mV whichever is greater, measured at 20 MHz bandwidth with 0.1 uf ceramic capacitor in parallel with 10 uf electrolytic capacitor connected at the end of the output connector at nominal line
06. Turn-ON/OFF Overshoot: 5% maximum, 1 mS typical recovery time for 25% step load
07. Turn-ON Delay: 1 Second typical.
08. Hold-Up Time: 8 mS typical at nominal input voltage and full load
09. Inrush Current: 30A typical at 115VAC input and 60A typical at 230VAC input
10. Switching Frequency: 65 KHz typical

B) PROTECTION

01. Over-Voltage: Protected with Zener clamp across the output
02. Short Circuit: Protected, unit will auto recover upon removal of fault
03. Input Protection: Input line fusing

C) SAFETY

01. Dielectric Withstand Voltage: 4242Vdc from primary to secondary
02. Touch Current: <0.25mA @ 240Vac input voltage
03. Earth continuity test:<0.1 Ohm or < 0.2 Ohm when with a non-detachable Power Supply cord, Class I Only

D) OTHER:

01. MTBF: 200,000 Hours @ 25°C ambient temperature
 02. Operating Temperature: 0°C to 40°C ambient temperature
 03. Humidity: 0% to 95% relative humidity
 04. Storage Temperature: -20°C to 80°C
- Normal performance after 2h recovery time at the room temperature without connection to mains
05. RoHS 2: Complies with EU 2011/65/EU and China SJ/T 11363-2006

E) ENCLOSURE

01. Housing: High impact plastic, 94V0 polycarbonate, non-vented
02. Size: 40.5 x 62.0 x 31.5 +/-1.0 mm
03. Markings: Label and/or Pad Printed and/or Molded in the case

Delivering leading edge, innovative power solutions for more than **30** years....

Model:GT-41134-06VV-x.x-Q

May 25, 2019

DERATING CURVE

Delivering leading edge, innovative power solutions for more than 30 years....

Model:GT-41134-06VV-x.x-Q

May 25, 2019

Input Configuration

Description Blade Options for Q Series Wall Plug-in Power Supplies

 Data Sheet: <http://en.globtek.com/interchangeable-blades.php>

 Insertion Instructions: <http://www.globtek.com/pdf/Instructions-Interchangeable-Blades.pdf>

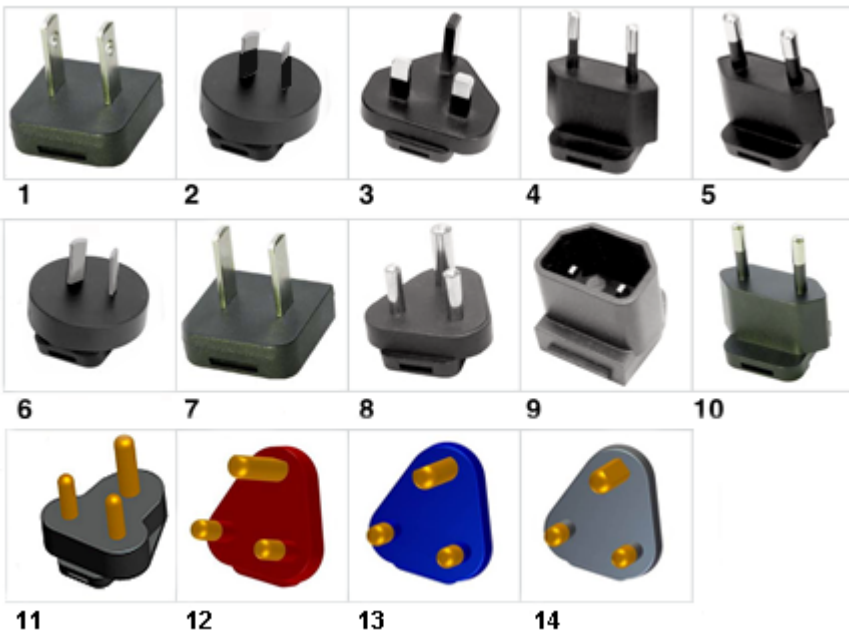
 Video: [Q-Blade Style Instruction Video](#)

INPUT CONNECTOR: Q-Socket (below are available blades configurations which are "not included" (unless stated above); can be purchased separately, package with power supply or as a separate "Q-KIT" if specified

- 01. United States / Canada / Japan NEMA 1-15P/IEC PLUG A [WORKS IN PLUG B] configuration: NA 2 blades, Class II; US/CA/JP P/N: Q-NA(R)
- 02. Australian AS 3112 configuration: SAA 2 blade/IEC TYPE I, Class II; AU P/N: Q-SAA(R)
- 03. UK BS 1363 configuration: UK 3 blade with dummy Ground/IEC TYPE G, Class II; GB P/N: Q-UK(R)
- 04. European CEE 7/16 configuration: Europlug 2 pins/IEC TYPE C [WORKS IN TYPE E&F], Class II; EU P/N: Q-EU(R)
- 05. Korean KS C8305 configuration: 2 pins/SIMILAR TO IEC TYPE C, Class II; KR P/N: Q-KR(R)
- 06. Argentina IRAM 2073 configuration: 2 blades/SIMILAR TO IEC TYPE I; AR P/N: Class II Q-AR(R)
- 07. China GB 2099 configuration: 2 blades/SIMILAR TO TYPE A, Class II; CN P/N: Q-CN(R)
- 08. India IS 1293 6A/BS546 configuration: 5A, 3 pins with Dummy Ground, Class II/IEC TYPE D; IN P/N: Q-IN(R)
- 09. IEC320/C18 Inlet, Class II; P/N: Q-C18(R)
- 10. Brazilian NBR6147 configuration: 2 pins, Class II; SIMILAR TO IEC TYPE C BR P/N: Q-BR(R)
- 11. South Africa SABS164-1, 3 round prongs, Class II + dummy ground, IEC TYPE M P/N: Q-SANS164-1-16A(R)
- 12. South Africa SABS164-4, 3 round prongs with a notched prong @ 0°, Class II + dummy ground, IEC TYPE M Red, P/N: Q-SANS164-4L-16A(R)

Delivering leading edge, innovative power solutions for more than **30** years....

Model:GT-41134-06VV-x.x-Q

May 25, 2019

13. South Africa SABS164-4, 3 round prongs with a notched prong @ -53°, Class II + dummy ground, Blue, IEC TYPE M, P/N:
Q-SANS164-4C-16A(R)
14. South Africa SABS164-4, 3 round prongs with a notched prong @ +53°, Class II + dummy ground, Black, IEC TYPE M P/N:
Q-SANS164-4R-16A(R)

Kits

- 01. Q-KIT: 1,2,3,4 above
- 02. Q-KIT-INTL: 2,3,4 above
- 03. Q-KIT-6: 1,2,3,4,5,6 above
- 04. Q-KIT-7: 1,2,3,4,5,6,7 above
- 05. Q-KIT-8: 1,2,3,4,5,6,7,8 above

Delivering leading edge, innovative power solutions for more than 30 years....

Model:GT-41134-06VV-x.x-Q

May 25, 2019

Output Configuration

Common output connector options:

 L Type (Coaxial
5.5x2.5mm plug)

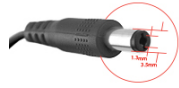
 C Type (Coaxial
5.5x2.1mm plug)

 K Type (Coaxial
3.5x1.3mm plug)

 LL Type (5.5x2.5mm
Locking 760k type)

 CL Type (5.5x2.1mm
Locking S761k type)

 ML2 Type (Molex
housing 43025-0200)

YL3 Type (KPPX-3P)



YL4 Type (KPPX-4P)

 EJ1/2/3/4/5 (EIAJ
RC-5320A type
connectors)

MSB Type (Micro USB)

 USBC Type (USB Type
C)

 Inquire for custom
design

 For a comprehensive list of options, [click here](#)













Contact GlobTek for your specific requirements or custom solutions.

Delivering leading edge, innovative power solutions for more than 30 years....

Model:GT-41134-06VV-x.x-Q

May 25, 2019







Approvals

Logo	Description
No Logo Applicable	IEC 60950-1:2005 (Second Edition) + A1:2009 + A2:2013
	CCC to GB4943.1-2011; GB/T9254-2008 GB17625.1-2012, Tropical <2000
	CE Mark: tested to comply with EN55022:2006/A1:2007 Class B, EN610003-2, EN610003-3 including EN610004-3, EN610004-4, EN610004-5, EN610004-6N EN610004-11; EMI: Complies with EN55011 CLA and FCC Part 15B - On label or Molded in case
	CHINA SJ/T 11364-2014, China RoHS Chart: http://en.globtek.com/globtek-rohs.php
	UL60950-1, cULus to UL 60950-1, 2nd Edition, 2007-03-27 and CSA C22.2 No. 60950-1-07, 2nd Edition, 2007
	Certification # TC RU AR46.B.75423 Custom Union of Russia, Belarus and Kazakhstan
No Logo	EC-Conformity Declaration: http://www.globtek.com/html/iso_certificates/EC-DECLARATION.pdf , REACH 144 SVHC: http://www.globtek.com/html/iso_certificates/Reach144.pdf
	FCC PART 15 CLASS B
	Indoor Use Only - Mark is on the label or Molded in the case
IP52	Ingress Protection: ?IP52 to IEC60529:2001 Protected against dust - limited ingress (no harmful deposit) and Protected against direct sprays up to 15 degrees from the vertical
	JAPAN TUV R-PSE, Cert. No. JD 50315169, to J60950-1(H26) , J55022(H22),[15V or less]. Please reference following website for guidelines on PSE regulations: http://en.globtek.com/importing-ite-and-medical-power-supplies-ac-adaptors-to-japan/
GlobTek, Inc.	
	JAPAN TUV R-PSE, Cert. No. JD 50315866, to J60950-1(H26) , J55022(H22),[15V or less]. Please reference following website for guidelines on PSE regulations: http://en.globtek.com/importing-ite-and-medical-power-supplies-ac-adaptors-to-japan/
GlobTek, Inc.	
	JAPAN TUV R-PSE, Cert. No. JD 50315866, to J60950-1(H26) , J55022(H22),[DC15V?30V]. Please reference following website for guidelines on PSE regulations: http://en.globtek.com/importing-ite-and-medical-power-supplies-ac-adaptors-to-japan/
GlobTek, Inc.	
	Korea KET KC Mark GT-41134-0612-4.5 HU10499-13016A (5V, 6V, 7.5V Only) http://www.globtek.info/certs/GT-41134%20Interchangeable/KOREAN-CERT-GT-41134-06-12-4.5%20K%206(2.0)(2011-12).pdf
	Efficiency: complies to section 301 of Energy Independence and Security Act (EISA) complies with Energy Star (North America), ECP tier 2 (China), MEPS tier 2 (Australia), Code of Conduct (Europe)

Delivering leading edge, innovative power solutions for more than **30** years....

Model:GT-41134-06VV-x.x-Q

May 25, 2019

<p>LPS  EEV1191  SAA-171833-EA RoHS   10276  </p>	<p>Limited Power Source Natural Resources Canada (NRCAN): CSA Standard C381.1-08, QSP NRCAN EEV1191; http://shop.csa.ca/en/canada/energy-efficiency/canca-c3811-08/invt/27024802008 RCM certificate SAA-171833-EA; Australia and New Zealand Regulatory Compliance, Mark (http://rcm.standards.org.au/rcmfaq/rcmfaq.htm) Specifications of directive 2011/65/EU Annex VI (ROHS-2) with amendment 2015/863-EU (ROHS-3) http://www.ce-mark.com/Rohs%20final.pdf S-Mark Certificate EN 60950-1:2006 + A11:2009 + A1:2010 + A12:2011 +A2:2013 (http://www.intertek.com/m) Ukraine UKRSepr (Document: www.globtek.com/html/iso_certificates/GT_Ukraine.pdf) Japan: Voluntary Control Council for Interference (VCCI) WEEE: Complies with EU 2012/19/EU (http://ec.europa.eu/environment/waste/weee/index_en.htm) Mark is on the label or Molded in the case</p>
---	---