

Delivering leading edge, innovative power solutions for more than 30 years....

Model:GT-81081-60VV-x.x-T3

May 20, 2019

GT-81081-60VV-x.x-T3

Information

Model Number GT-81081-60VV-x.x-T3

Description GT-81081-60VV-x.x-T3, ITE Power Supply, Desktop/External, Regulated Switchmode AC-DC Power Supply AC Adaptor, , Input Rating: 100-240V- , 50/60Hz, IEC 60320/C14 AC Inlet Connector, Class I, Earth Ground, Output Rating: 60 Watts, Power rating with convection cooling (W) , 12-24V in 0.1V increments, Approvals: FCC; China RoHS; CE; CB 60950; VCCI; NrCAN; WEEE; RoHS; EMC; NOM; SGS (Brazil); Ukraine; CCC; Class I; IRAM; PSE; cULus; Level IV 115V; Level III 230V; NEMKO 60950; Korea (24V Only); ITE; Level 3; Korea (12V Only); IP40; Korea (15V Only); India; Singapore(12V); Singapore (15V); CU Kazakhstan; RCM; LPS;

Model Picture



Agency Documents <http://www.globtek.info/certs/GT-81081/>

CE Declaration https://www.globtek.com/pdf/ec_declaration/a0O30000007P7ZgEAK

RoHS/RoHS2 Declaration https://www.globtek.com/pdf/rohs_cert/a0O30000007P7ZgEAK

REACH Declaration https://www.globtek.com/pdf/iso_certificates/REACH.pdf

Conflict Minerals Declaration <https://www.globtek.com/pdf/conflict-minerals.pdf>

Delivering leading edge, innovative power solutions for more than **30** years....

Model:GT-81081-60VV-x.x-T3

May 20, 2019

Model Parameters

Type	Desktop/External
Technology	Regulated Switchmode AC-DC Power Supply AC Adaptor
Category	ITE Power Supply
Input Voltage	100-240V- , 50/60Hz
I/P Amps (A)	1.5A
Wattage (W)	60.0
Vout Range (V)	12-24
Efficiency Level	IV @ 115V / III @ 230V
Ingress Protection	IP40
Size (mm)	121*56*32

Delivering leading edge, innovative power solutions for more than **30** years....

Model:GT-81081-60VV-x.x-T3

May 20, 2019

ENCLOSURE

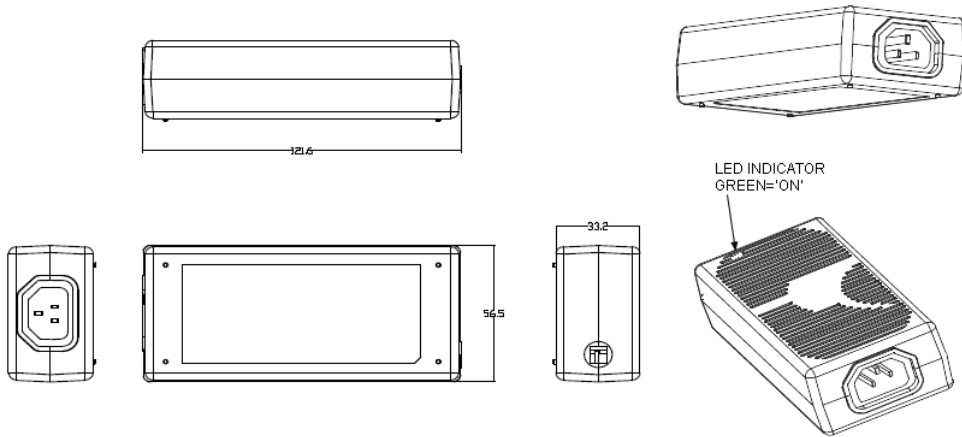

Delivering leading edge, innovative power solutions for more than **30** years....

Model:GT-81081-60VV-x.x-T3

May 20, 2019

RATING TABLE

Model Number	Voltage	Amps(A)	Watts(W)	RFQ
GT-81081-6012-T3	12 V	5	60.00	RFQ
GT-81081-6014-0.8-T3	13.2 V	4.5	59.40	RFQ
GT-81081-6014-T3	14 V	4.3	60.20	RFQ
GT-81081-6015-T3	15 V	4	60.00	RFQ
GT-81081-6018-T3	18 V	3.33	59.94	RFQ
GT-81081-6019-T3	19 V	3.15	59.85	RFQ
GT-81081-6020-T3	20 V	3	60.00	RFQ
GT-81081-6022-T3	22 V	2.72	59.84	RFQ
GT-81081-6024-T3	24 V	2.5	60.00	RFQ

Delivering leading edge, innovative power solutions for more than 30 years....

Model:GT-81081-60VV-x.x-T3

May 20, 2019

SPECIFICATIONS

A) ELECTRICAL SPECIFICATIONS:

1. Input Voltage: Specified 90-264 Vac, Nameplate rated 100-240 Vac
2. Input Frequency: Specified 47-63 Hz, Nameplate rated 50-60 Hz
3. Output Load Regulation: +/- 5% measured at the output connector
4. Line Voltage Regulation: +/- 1% typical measures at the Output connector
5. Output Ripple (peak to peak): 1% or 50 mV whichever is greater measured at nominal output voltage. measured at 20 MHz bandwidth with 0.1 μ f ceramic capacitor in parallel with 10 μ f electrolytic capacitor connected at the end of output connector
6. Turn-On/Turn-Off Overshoot: 5% maximum, 500 μ s recovery time for 25% step load
7. Turn-On Delay: 2 sec max
8. Hold-Up Time: 8 mSec Min at 120Vac, Input and full load
9. Inrush Current: 40A max at cold start at 120vac and 60A at 230Vac
10. Switching Frequency: 100 KHz typical
11. Efficiency: 84% typical at full load

B) PROTECTION

1. Over-Voltage: Protected, unit will autorecover upon removal of fault
2. Short Circuit: Protected, unit will autorecover upon removal of fault
3. Input Protection: Input line fusing

C) SAFETY

1. Dielectric Withstand Voltage: 4242Vdc from primary to secondary
2. Touch Current: <0.25mA @ 240Vac input voltage
3. Earth Leakage Current: <3.5 mA at 240Vac
4. Earth continuity test:<0.1 Ohm or < 0.2 Ohm when with a non-detachable Power Supply cord, Class I Only

D) OTHER:

1. MTBF: 200,000 hours @ 25°C ambient temperature
2. Operating Temperature: 0°C to 40°C ambient temperature
3. Humidity: 5% to 95% relative humidity
4. Storage Temperature: -40°C to 80°C
5. RoHS 2: Complies with EU 2011/65/EU and China SJ/T 11363-2006

E) ENCLOSURE

1. Upper Housing: High impact plastic, 94V0 polycarbonate, non-vented
2. Lower Housing: High impact plastic, 94V0 polycarbonate, non-vented
3. Size: 121.6*56.5*33.2 +/-1.0 mm
4. LED: Green Indicator for output present

Delivering leading edge, innovative power solutions for more than **30** years....

Model:GT-81081-60VV-x.x-T3

May 20, 2019

DERATING CURVE

Delivering leading edge, innovative power solutions for more than 30 years....

Model:GT-81081-60VV-x.x-T3

May 20, 2019

Input Configuration

Description IEC 60320/C14 AC Inlet Connector, Class I, Earth Ground



Mates with IEC 60320/C13 Plug

Optional Locking IEC60320 Receptacle and cord option available on some models by request.:

[Standard International IEC 320/C13 Cordsets](#)

Below are standard cordsets which are "not included" (unless stated above); these can be purchased separately or packaged with the power supply. Contact your Sales Engineer if the style required is not shown below. Many more available in different lengths, colors or cable material.

Stock Power Supply Cords

Part Number/ Link	Country	Plug	Termination	Length (mm)	(Ft)
3021457F701(R)	N. American (Type B)	NEMA 5-15P	IEC 320/C13	2150	7
1191068F0701(R)	N. American (Type B)	NEMA 5-15P Hospital	IEC 320/C13	2459	8
2194272M5701-T(R)	Argentina (Type I)	IRAM 2073	IEC 320/C13	2500	8
5502022M5701A(R)	Australian (Type I)	AS3112 / 3 PRONG	IEC 320/C13	2500	8
204B4272M5701(R)	Brazil (Type N)	BRAZIL	IEC 320/C13	2500	8
6023602M5701(R)	China (Type I)	CCC GR2099	IEC 320/C13	2500	8
G8014272M5701(R)	Danish (Type K)	AFSNIT SECTION 107-2-D1	IEC 320/C13	2500	8
23144272M5701-T(R)	Europe (Type E)	CEE 7/7	IEC 320/C13	2500	8
205IN4272M5701(R)	India (Type D)	India IS 1293 (also known as IA16A3 or BS546)	IEC 320/C13	2500	8
208IN4272M5701(R)	India (Type M)	India IS 1293 (also known as IA16A3 or BS546)	IEC320/C13	2500	8
377C4272M5701(R)	Israel (Type H)	ISL 377C	IEC 320/C13	2500	8
23024272M5701(R)	Italy (Type L)	CEI 23-16/VII	IEC 320/C13	2500	8
3003339F701(R) [3x1.25mm2]	Japan (Type B)	JIS 8303 / 3 PINS	IEC 320/C13	2500	8

Delivering leading edge, innovative power solutions for more than **30** years....

Model:GT-81081-60VV-x.x-T3

May 20, 2019

3003068F2701-HK(R) [3 x 2.0mm2]						
302J115J6F0701J(R)	Japan / North America (Type B – 12A)	JIS 8303 / 3 PINS and NEMA 5-15P (PSE and UL/CUL appr)	IEC 320/C13	1830	6	
302J104J6F0701J(R)	Japan / North America (Type B – 15A)	JIS 8303 / 3 PINS and NEMA 5-15P (PSE and UL/CUL appr)	IEC 320/C13	1830	6	
2313K3432M5701(R)	Korea (Type F)	KS C 8305	IEC 320/C13	2500	8	
5804272M5701(R)	Russia (Type F)	GOST 7396	IEC 320/C13	2500	8	
205SA4272M5701(R)	South Africa (Type D)	South Africa SABS164-1 (6A type)	IEC 320/C13	2500	8	
2084272M5701(R)	South Africa (Type M)	South Africa SABS164-1 (16A type)	IEC 320/C13	2500	8	
23214272M5701(R)	Switzerland (Type J)	SEV 1011	IEC 320/C13	2500	8	
3003322M5701(R)	Taiwan (Type B)	BSMI	IEC 320/C13	2500	8	
PZ0800100-2M5BK13H(R)	UK, Hong Kong, Singapore, Gulf States (Type G)	BS 1363A	IEC 320/C13	2500	8	
7055002M5701A(R)	International	IEC 320 C14-C13	IEC 320/C13	2500	8	

Delivering leading edge, innovative power solutions for more than 30 years....

Model:GT-81081-60VV-x.x-T3

May 20, 2019

Output Configuration

Common output connector options:

 L Type (Coaxial
5.5x2.5mm plug)

 C Type (Coaxial
5.5x2.1mm plug)

 K Type (Coaxial
3.5x1.3mm plug)

 LL Type (5.5x2.5mm
Locking 760k type)

 CL Type (5.5x2.1mm
Locking S761k type)

 ML2 Type (Molex
housing 43025-0200)

YL3 Type (KPPX-3P)



YL4 Type (KPPX-4P)

 EJ1/2/3/4/5 (EIAJ
RC-5320A type
connectors)

MSB Type (Micro USB)

 USBC Type (USB Type
C)

 Inquire for custom
design

 For a comprehensive list of options, [click here](#)







Contact GlobTek for your specific requirements or custom solutions.

Delivering leading edge, innovative power solutions for more than 30 years....

Model:GT-81081-60VV-x.x-T3

May 20, 2019















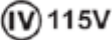

Approvals

Logo	Description
	Attention Mark / Refer to operating manual for operating and service instructions
No Logo Applicable	CB report 60950-1 2nd Ed
	CCC to GB4943.1-2011; GB/T9254-2008 GB17625.1-2012, Tropical <2000
	CE Mark: tested to comply with EN55022:2006/A1:2007 Class B, EN610003-2, EN610003-3 including EN61000-4-2, EN61000-4-3, EN61000-4-4, EN61000-4-5, EN61000-4-6N EN61000-4-11; EMI: Complies with EN55011 CLASS B and FCC Part 15B - On label or Molded in case
	CHINA SJ/T 11364-2014, China RoHS Chart: http://en.globtek.com/globtek-rohs.php
адаптер питания	CU Kazakhstan Certificate
	UL60950-1, cULus to UL 60950-1, 2nd Edition, 2007-03-27 and CSA C22.2 No. 60950-1-07, 2nd Edition, 2007-03
	EMC Inspected
	FCC PART 15 CLASS B I.T.E. POWER SUPPLY
IS 13252 (Part 1) IEC 60950-1  R-41017175 www.bis.gov.in	Bureau Of Indian Standards for GT-81081-6012-T3, GT-81081-6014-0.8-T3, GT-81081-6015-T3,
 IP40	Indoor Use Only - Mark is on the label or Molded in the case Ingress Protection: ?IP40 to IEC60529:2001 Protection against granular foreign bodies
 DC-E-071-001.2	IRAM certificate to IEC 60950-1:2005 + A1:2009
PRECAUCION: PARA USO EN EQUIPOS ELECTRONICOS SOLAMENTE	

Delivering leading edge, innovative power solutions for more than 30 years....

Model:GT-81081-60VV-x.x-T3

May 20, 2019

 KTC HU10499-10004A 직류전원장치 AC/DC ADAPTER KTC HU10499-14019A MSIP-REM-GSZ-81081-6015 최저소비효율기준 만족 제품 모델명:GT-81081-6015-T3 Mfr. Name: GLOBTEK (SUZHOU) A/S Center: 10-6221-6100	Korea KET KC Mark GT-81081-6012-T3 HU10499-10004A (12V, 14V Only)
 직류전원장치 AC/DC ADAPTER KTC HU10499-14019A MSIP-REM-GSZ-81081-6015 최저소비효율기준 만족 제품 모델명:GT-81081-6015-T3 Mfr. Name: GLOBTEK (SUZHOU) A/S Center: 10-6221-6100	Korea KET KC Mark GT-81081-6015-T3&T3A HU10499-14019A (14V, 14.1V, 15V, 16V, 19V)
 직류전원장치 AC/DC ADAPTER KTC HU10499-12009A 직류전원장치 AC/DC ADAPTER KTC HU10499-12009A MSIP-REM-GSZ-81081-6024-T3 최저소비효율기준 만족 제품 모델명:GT-81081-6024-T3 Mfr. Name: GLOBTEK (SUZHOU) A/S Center: 10-6221-6100	Korea KET KC Mark GT-81081-6024-T3,T3A,T3CCHU10499-12009A (20V, 22V, 24V)
LEVEL 3  230V EFFICIENCY LEVEL  115V LPS  Apparatet må tilkoples jorden stikkontakt  Fuente de alimentación de ITE  EEV1191  GlobTek, Inc.  N136 SAA111102EA	LEVEL 3 Efficiency: complies to section 301 of Energy Independence and Security Act (EISA) complies with Energy Star tier 2 (North America), ECP tier 2 (China), MEPS tier 2 (Australia), Code of Conduct (Europe) Efficiency: complies to section 301 of Energy Independence and Security Act (EISA) complies with Energy Star tier 2 (North America), ECP tier 2 (China), MEPS tier 2 (Australia), Code of Conduct (Europe) Limited Power Source Nemko w Class I Warning Nemko EN60950-1:2006, A11, A1, A12
Fuente de alimentación de ITE  EEV1191  GlobTek, Inc.  N136 SAA111102EA	NOM (Mexico) to NOM-001-SCFI-1993 GT-81081-60XX-T3 for 12V,13.2V,14V,15V only Natural Resources Canada (NRCAN): CSA Standard C381.1-08, QSP NRCAN EEV1191; http://shop.csa.ca/en/canada/energy-efficiency/cancca-c3811-08/inv/27024802008 JAPAN TUV Rheinland-PSE GlobTek Inc to J60950-1(H26) , J55022(H22),J3000(H25).Please follow the procedure listed in the following link for proper import to Japan: http://en.globtek.com/importing-to-japan.php .
RoHS  RoHS000158101/07 RoHS Symbol Serial NO. YEAR WEEK Class NO for production	RCM certificate SAA111102EA; Australia and New Zealand Regulatory Compliance, Mark (http://rcm.standards.org.au/rcmfaq/rcmfaq.htm Specifications of directive 2011/65/EU Annex VI (ROHS-2) with amendment 2015/863-EU (ROHS-3) http://www.ce-mark.com/Rohs%20final.pdf
 SGS PRODUCT SAFETY www.safety.sgs.com	SGS (Brazil) to IEC 60950-1_2005 + A1_2009 +A2_2013 (12 - 24 Volts)
 SAFETY MARK 151311-12	Singapore GT-81081-6015-T3 ICE 60950-1:2005 + A1:2009 +A2:2013 151311-12 (15 v only)

Delivering leading edge, innovative power solutions for more than **30** years....

Model:GT-81081-60VV-x.x-T3

May 20, 2019



151400-12



10276



Singapore GT-81081-6012-T3 ICE 60950-1:2005 + A1:2009 +A2:2013 sert.# 151400-12 (12V only)

Ukraine UKRSepro (Document: www.globtek.com/html/iso_certificates/GT_Ukraine.pdf)

Japan: Voluntary Control Council for Interference (VCCI)

WEEE: Complies with EU 2012/19/EU (http://ec.europa.eu/environment/waste/weee/index_en.htm)

Mark is on the label or Molded in the case