

Delivering leading edge, innovative power solutions for more than 30 years....

Model:GT-21096-WWVV-F

June 24, 2019

GT-21096-WWVV-F

Information

Model Number GT-21096-WWVV-F

Description GT-21096-WWVV-F, ITE Power Supply, Open Frame/Internal, Regulated Switchmode AC-DC Power Supply AC Adaptor, , Input Rating: 100-240V~, 50-60 Hz, Molex 09-65-2058 5 Position Header Pin 1: Earth, Pin 2: Removed, PIN 3: Neutral, Pin 4: removed, Pin 5: Line, Output Rating: 19 Watts, Power rating with convection cooling (W) , 3.3-48V in 0.1V increments, Approvals: CB 60950; Designed to meet EN 60601-1; WEEE; RoHS; China RoHS; VCCI; cRUus; CE; EAC; Ukraine; Class I; SIQ;

Model Picture

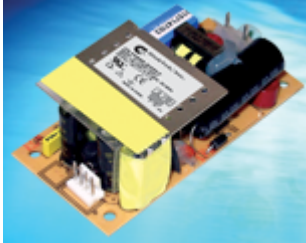

Agency

Documents <http://www.globtek.info/certs/GT-21096/>

CE

EC-Declaration https://www.globtek.com/pdf/ec_declaration/a0O30000007P7Z7EAK

RoHS/RoHS2

Declaration https://www.globtek.com/pdf/rohs_cert/a0O30000007P7Z7EAK

REACH

Declaration https://www.globtek.com/pdf/iso_certificates/REACH.pdf

Conflict

Minerals <https://www.globtek.com/pdf/conflict-minerals.pdf>

Declaration

Delivering leading edge, innovative power solutions for more than **30** years....

Model:GT-21096-WWVV-F

June 24, 2019

Model Parameters

Type	Open Frame/Internal
Technology	Regulated Switchmode AC-DC Power Supply AC Adaptor
Category	ITE Power Supply
Input Voltage	100-240V~, 50-60 Hz
I/P Amps (A)	0.5A MAX
Wattage (W)	19.0
Vout Range (V)	3.3-48
Efficiency Level	N/A
Ingress Protection	IPX0
Size (mm)	

Delivering leading edge, innovative power solutions for more than 30 years....

Model:GT-21096-WWVV-F

June 24, 2019

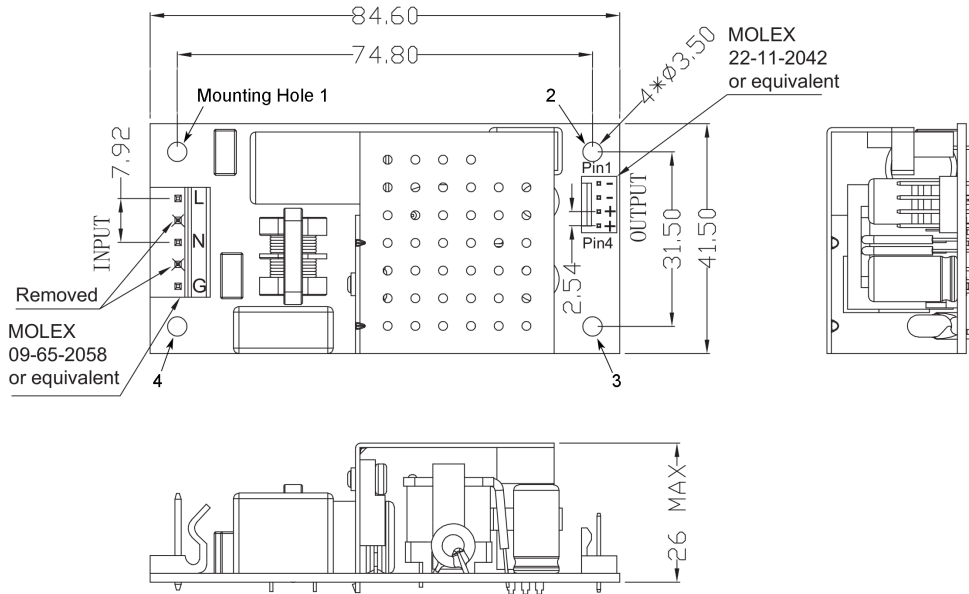
ENCLOSURE

IMPORTANT INSTALLATION NOTES:

FOR PROPER INSULATION AND GROUNDING RELIABILITY, FOLLOW EITHER OPTIONS BELOW

OPTION 1: USE NYLON 4-40 SCREWS AND NYLON STAND-OFF FOR ALL MOUNTING HOLES AND ADD JUMPER WIRE OPTION SHOWN BELOW FOR EARTH CONNECTION BETWEEN MOUNTING HOLES 4 AND 3.



RING TERMINAL, AMP P/N: 8-34142-5 AWG 18 STRANDED WIRE, GREEN, 100 mm LENGTH

OPTION 2. USE METALLIC 4-40 SCREWS AND METALLIC STAND-OFF FOR HOLES 3 AND 4 AND USE NYLON 4-40 SCREWS AND NYLON STAND-OFF FOR HOLES 1 AND 2.

OPTION 2 IS ONLY APPLICABLE IF SYSTEM CHASSIS WHERE THE POWER SUPPLY IS MOUNTED IS MADE OUT OF METAL.

Delivering leading edge, innovative power solutions for more than **30** years....

Model:GT-21096-WVVV-F

June 24, 2019

RATING TABLE

Model Number	Voltage	Amps(A)	Watts(W)	RFQ
GT-21096-0903-F	3.3 V	2.6	8.58	RFQ
GT-21096-1505-F	5 V	2.6	13.00	RFQ
GT-21096-1305-F	5 V	2.6	13.00	RFQ
GT-21096-1506-F	6 V	2.5	15.00	RFQ
GT-21096-1509-1.5-F	7.5 V	2	15.00	RFQ
GT-21096-1509-F	9 V	1.7	15.30	RFQ
GT-21096-1512-F	12 V	1.25	15.00	RFQ
GT-21096-1815-F	15 V	1.2	18.00	RFQ
GT-21096-1818-F	18 V	1	18.00	RFQ
GT-21096-1824-F	24 V	0.75	18.00	RFQ
GT-21096-1948-F	48 V	0.4	19.20	RFQ

SPECIFICATIONS

A) ELECTRICAL SPECIFICATIONS:

01. Input Voltage: Specified 90-264 Vac, Nameplate rated: 100-240Vac
02. Input Frequency: Specified 47-63 Hz, Nameplate rated 50-60Hz
03. Output Regulation: +/- 5% measured at the output connector
04. Line Voltage Regulation: +/- 1% typical measured at full load
05. Output Ripple (Vp-p): +/- 1% of output voltage, Vp-p, typical
06. Turn-ON/OFF: 5% maximum, 1 mS typical recovery time for 25% step load
07. Turn-ON Delay: 1 Sec, typical
08. Hold-Up Time: 8 mS typical @ nominal input voltage and full load
09. Inrush Current: 30A maximum cold start @ 115 Vac input, 60A maximum cold start @ 230 Vac input
10. Switching Frequency: 100 KHz typical, varies with line and load
11. Efficiency: 75% typical at nominal input and full load

B) PROTECTION

01. Over-Voltage: limited via crowbar method
02. Earth Leakage Current: <3.5 mA at 240Vac input voltage
03. Short Circuit/Over-load: momentary short circuit protected, output will autorecover upon removal of short
04. Input Protection: Input line

C) SAFETY

01. Dielectric Withstand Voltage: 4242 Vdc from primary to secondary
02. Touch Current: <0.25mA at 240 Vac input voltage
03. Earth continuity test:<0.1 Ohm or < 0.2 Ohm when with a non-detachable Power Supply cord
04. Type of protection against electric shock: class I
05. Degree of protection against electric shock: not classified(no applied part)
06. Mode of operation: Continuous
07. ROHS 2: Complies with EU 2011/65/EU and China SJ/T 11363-2006

D) OTHER:

01. MTBF: 200,000 Hours @ 25°C ambient temperature
02. Operating Temperature: 0°C to 30°C ambient temperature
03. Humidity: 0% to 90% relative humidity
04. Storage Temperature: -10°C to 80°C
05. Cooling: Convection

E) ENCLOSURE

01. Housing: Open Frame
02. Size: 84.6 x 41.4 x 28.9 mm

Delivering leading edge, innovative power solutions for more than **30** years....

Model:GT-21096-WVVV-F

June 24, 2019

DERATING CURVE

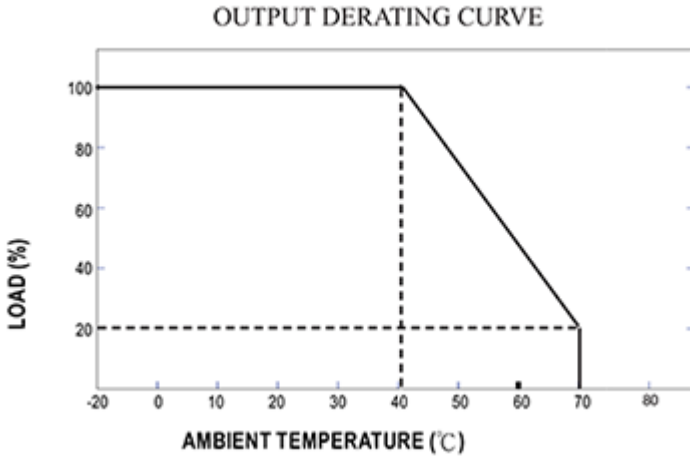

Delivering leading edge, innovative power solutions for more than 30 years....

Model:GT-21096-WWVV-F

June 24, 2019

Input Configuration

Description Molex 09-65-2058 5 Position Header Pin 1: Earth, Pin 2: Removed, PIN 3: Neutral, Pin 4: removed, Pin 5: Line

Document: http://www.molex.com/pdm_docs/sd/009652058_sd.pdf

Catalog Page: http://www.molex.com/molex/products/datasheet.jsp?part=active/0009652058_PCB_HEADERS.xml

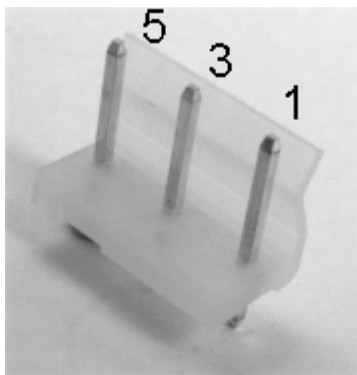
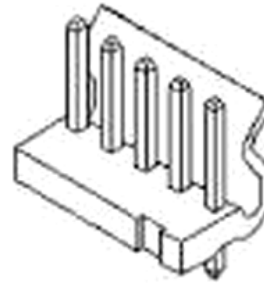
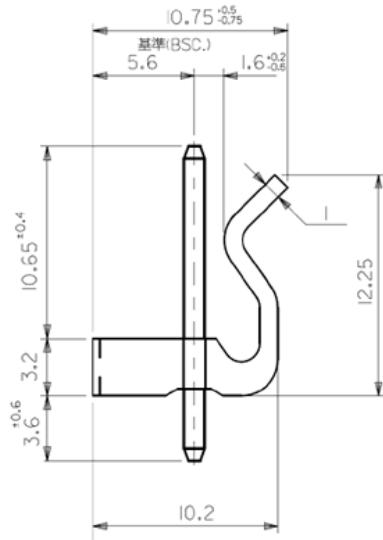

Mates With Part(s):











5195 SPOX™ Crimp Housing, **5239** KK® Crimp Housing

Delivering leading edge, innovative power solutions for more than 30 years....

Model:GT-21096-WWVV-F

June 24, 2019

Approvals

Logo	Description
	Attention Mark / Refer to operating manual for operating and service instructions
No Logo	CB Certificate IEC 60950-1:2005 (2nd Edition), Am 1: 2009, CB report IEC 60950-1:2005 (2nd Edition), Am 1: 2009 and EN 60950-1:2006 + Am 1:2010 + Am 11:2009 + Am 12:2011
	CE Certification
	CHINA SJ/T 11364-2014, China RoHS Chart: http://en.globtek.com/globtek-rohs.php
	Class I Earth Ground
	UL Registered E170507 CSA C22.2 No. 60950-1-03 1st Ed.
No Logo	Designed to meet EN 60601-1:2006 + A11:2011 +A1:2013 3rd Edition
	Declaration # EA3C N RU Д-US.АД75.В.01052 Custom Union of Russia, Belarus and Kazakhstan http://www.globtek.com/redirect/?loc=gost-certificate-eac-declaration
	Indoor Use Only - Mark is on the label or Molded in the case
RoHS	Specifications of directive 2011/65/EU Annex VI (ROHS-2) with amendment 2015/863-EU (ROHS-3) http://www.ce-mark.com/Rohs%20final.pdf
	SIQ Mark EN 60950-1 :2006 +A 1 :2010 +A 11 :2009 +A 12:2011 + A2:2013
	Ukraine UKRSepr (Document: www.globtek.com/html/iso_certificates/GT_Ukraine.pdf)
10276	
	Japan: Voluntary Control Council for Interference (VCCI)
	WEEE: Complies with EU 2012/19/EU (http://ec.europa.eu/environment/waste/weee/index_en.htm) Mark is on the label or Molded in the case