

Delivering leading edge, innovative power solutions for more than 30 years....

Model:GTM91120-30VV-P2(SR with SAA Plug 2 pin)

August 18, 2019

GTM91120-30VV-P2(SR with SAA Plug 2 pin)

Information

Model Number GTM91120-30VV-P2(SR with SAA Plug 2 pin)

Description

GTM91120-30VV-P2(SR with SAA Plug 2 pin), ITE / Medical Power Supply, 60601-1-4th Ed. , Potted/Encapsulated in plastic housing, Regulated Switchmode AC-DC Power Supply AC Adaptor, , Input Rating: 100-240V~, 50-60 Hz, Australian AS 3112 configuration: SAA 2 pins Class II, Output Rating: 30 Watts, Power rating with convection cooling (W) , 5-48V in 0.1V increments, Approvals: EAC; WEEE; Fuse 60335; Book 60601; CB 60601-1; CB 60335; CB 60950; CB EN/IEC 60335-1; CE; CE; CE; ETL; China RoHS; cRUus; cRUus; Double Insulation; FCC; IEC 60335; IEC/EN60601-1; IEC/EN60950-1; IP68; Level V; LPS; PSE; SIQ; SIQ; Ukraine; VCCI;

Model Picture



Agency Documents
CE

<http://www.globtek.info/certs/GTM91120-P2%20-P3/>

EC-Declaration

https://www.globtek.com/pdf/ec_declaration/a000c00000PzSZhEAN

RoHS/RoHS2 Declaration

https://www.globtek.com/pdf/rohs_cert/a000c00000PzSZhEAN

REACH Declaration

https://www.globtek.com/pdf/iso_certificates/REACH.pdf

Conflict

Minerals

<https://www.globtek.com/pdf/conflict-minerals.pdf>

Declaration

Delivering leading edge, innovative power solutions for more than **30** years....

Model:GTM91120-30VV-P2(SR with SAA Plug 2 pin)

August 18, 2019

Model Parameters

Type	Potted/Encapsulated in plastic housing
Technology	Regulated Switchmode AC-DC Power Supply AC Adaptor
Category	ITE / Medical Power Supply
Input Voltage	100-240V~, 50-60 Hz
I/P Amps (A)	1.5A
Wattage (W)	30.0
Vout Range (V)	5-48
Efficiency Level	V
Ingress Protection	IP68
Size (mm)	

Delivering leading edge, innovative power solutions for more than **30** years....

Model:GTM91120-30VV-P2(SR with SAA Plug 2 pin)

August 18, 2019

ENCLOSURE

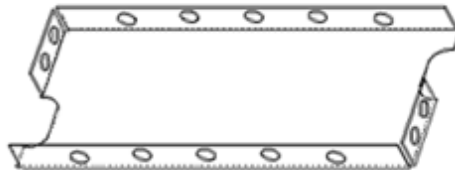
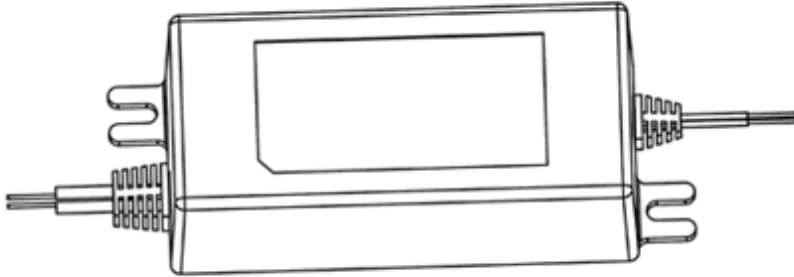
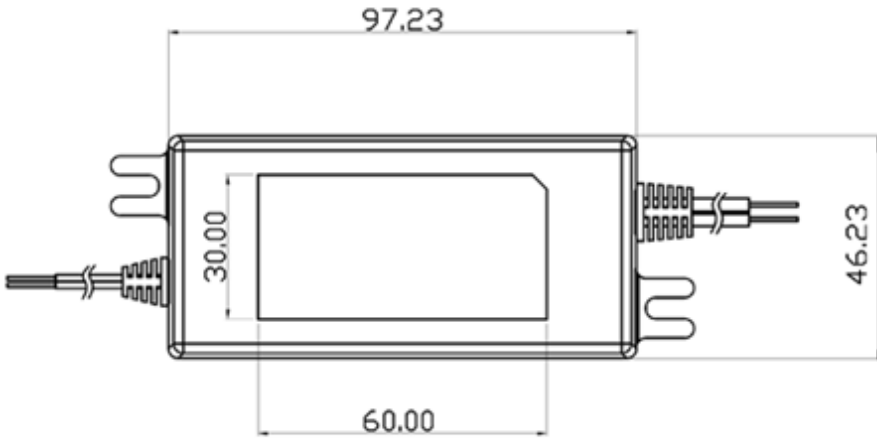

MYLAR CASE COVER INSTALLED

Delivering leading edge, innovative power solutions for more than **30** years....

Model:GTM91120-30VV-P2(SR with SAA Plug 2 pin)

August 18, 2019

RATING TABLE

Model Number Voltage(Amps(A) Watts(W) RFQ

Delivering leading edge, innovative power solutions for more than 30 years....

Model:GTM91120-30VV-P2(SR with SAA Plug 2 pin)

August 18, 2019

SPECIFICATIONS**A) ELECTRICAL SPECIFICATIONS:**

1. Input Voltage: Specified 90-264 Vac, Nameplate rated: 100-240Vac
2. Input Frequency: Specified 47-63 Hz, Nameplate rated 50-60Hz
3. Output Regulation: +/- 5% measured at the output connector
4. Line Voltage Regulation: +/- 2% typical measured at full load
5. Output Ripple (Vp-p): +/-2% maximum, measured at 20 MHz bandwidth with 0.1 uf ceramic capacitor in parallel with 10 uf electrolytic capacitor connected at the end of the output connector at nominal line
Optional low ripple option available (RFP4579)
6. Turn-ON/OFF Overshoot: 5% maximum, 500uS typical recovery time for 25% to 50% step load
7. Turn-ON Delay: 3 Seconds, maximum @ full load, nominal line
08. Hold-Up Time: 5mS typical @ nominal input voltage and full load
09. Inrush Current: 60A maximum cold start @ 240Vac input
10. Switching Frequency: 100 KHz typical

B) PROTECTION

1. Over-Voltage: Protected with a Zener diode clamp across the output
2. Short Circuit: Hiccup with auto recovery
3. Over-load: Hiccup with auto recovery
4. Input Protection: Input line and neutral fusing

C) SAFETY

1. Dielectric Withstand Voltage: 5656Vdc from primary to secondary
2. Earth Leakage Current: N/A for Class II units, there is no PE Ground pin, so Earth Leakage current is not measured
3. Touch Current: Maximum allowed values: 100uA NC(Normal condition) 500uA SFC(single fault condition)

D) OTHER:

1. MTBF: 200,000 Hours @ 25°C ambient temperature
2. Operating Temperature: -10°C to 40°C ambient temperature (RFP RFI-50576)
3. Humidity: 0% to 90% relative humidity
4. Storage Temperature: -10°C to 80°C
5. Cooling: Convection
6. ROHS 2: Complies with EU 2011/65/EU and China SJ/T 11363-2006
7. For EMI suppression 28A026-0A2 Snap-on Ferrites are recommended on both input and output cables, if required.

E) ENCLOSURE

1. Housing: High impact plastic, 94V0 polycarbonate, non-vented
2. Size: 97.23 x 46.23 x 32.0 +/- 1.0 mm
3. Markings: Label and/or Pad Printed and/or Molded in the case
4. Ingress Protection: IP68, Dust Tight, No ingress of dust, complete protection against contact as well as Protected against liquid Immersion beyond 1 m

Delivering leading edge, innovative power solutions for more than **30** years....

Model:GTM91120-30VV-P2(SR with SAA Plug 2 pin)

August 18, 2019

DERATING CURVE

Delivering leading edge, innovative power solutions for more than 30 years....

Model:GTM91120-30VV-P2(SR with SAA Plug 2 pin)

August 18, 2019

Input Configuration

Description Australian AS 3112 configuration: SAA 2 pins Class II

Used in [Australia](#), [New Zealand](#), [Fiji](#), [Papua New Guinea](#) and [Tokelau](#), has two flat pins forming an inverted V-shape. These flat blades measure 6.3 by 1.5 mm with the Active and Neutral pins of 17 mm in length set 30° to the vertical on a nominal pitch of 13.7 mm. A standard power outlet in Australia provides a nominal voltage of 230 volts at a maximum of 10 amps and always includes an earth connection. As in the UK, its outlets are individually switched for extra safety. [Argentina](#) uses a similar plug, with pins 1 mm longer.

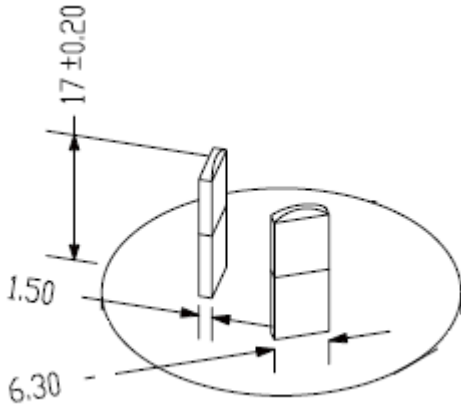

Delivering leading edge, innovative power solutions for more than 30 years....

Model:GTM91120-30VV-P2(SR with SAA Plug 2 pin)

August 18, 2019

Output Configuration

Common output connector options:

 L Type (Coaxial
5.5x2.5mm plug)

 C Type (Coaxial
5.5x2.1mm plug)

 K Type (Coaxial
3.5x1.3mm plug)

 LL Type (5.5x2.5mm
Locking 760k type)

 CL Type (5.5x2.1mm
Locking S761k type)

 ML2 Type (Molex
housing 43025-0200)

YL3 Type (KPPX-3P)



YL4 Type (KPPX-4P)

 EJ1/2/3/4/5 (EIAJ
RC-5320A type
connectors)

MSB Type (Micro USB)

 USBC Type (USB Type
C)

 Inquire for custom
design

 For a comprehensive list of options, [click here](#)

Contact GlobTek for your specific requirements or custom solutions.

Delivering leading edge, innovative power solutions for more than 30 years....

Model:GTM91120-30VV-P2(SR with SAA Plug 2 pin)

August 18, 2019















Approvals

Logo	Description
	Attention Mark / Refer to operating manual for operating and service instructions
	Book 60335 up to 36 Volts
	60601-1 3rd Operating Instructions
No Logo Applicable	CB report IEC 60601-1: 2005 + CORR. 1 (2006) + CORR. 2 (2007) and or EN 60601-1:2006 3rd Edition including 2MOOP requirements
No Logo Applicable	IEC 60335-1:2010 (Fifth Edition) incl. Corr. 1:2010 and Corr. 2:2011 + A1:2013
No Logo	CB Certificate IEC 60950-1:2005 (2nd Edition), Am 1: 2009, CB report IEC 60950-1:2005 (2nd Edition), Am 1: 2009 and EN 60950-1:2006 + Am 1:2010 + Am 11:2009 + Am 12:2011
No Logo Applicable	CB to 60335-1 5th Edition (Safety of Household and Similar Electrical Appliances, Part 1: General Requirements) CB Report/ Certificate IEC 60335-1:2010 Up to 36 volts only
	CE Mark: tested to comply with EN 55032:2012+AC:2013, EN 61000-3-2:2014, EN 61000-3-3:2013, EN 55024:2010, EN 60601-1-2:2015
	CE Mark: tested to comply with EN55022:2006/A1:2007 Class B, EN61000-2, EN61000-3 including EN61000-4-2, EN61000-4-3, EN61000-4-4, EN61000-4-5, EN61000-4-6N EN61000-4-11; EMI: Complies with EN55011 CLASS B and FCC Part 15B - On label or Molded in case
	CE Mark: tested to comply with EN61000-3-2, EN61000-3-3 and EN50082-1, including EN61000-4-2, EN61000-4-3, EN61000-4-4, EN61000-4-5, EN61000-4-6, EN61000-4-8, EN61000-4-11, EN61001-1-2-2007 EMI: Complies with EN55011 CLASS B and FCC Part 15 B
	AAMI ES60601-1:2005 +A1 - Medical Electrical Equipment - Part 1: General Requirements CAN/CSA-C22.2 No.60601-1:14, Third Edition Issued: 2014/03/01 - Medical Electrical Equipment - Part 1 IEC 60601-1-11 Issued: 2015/01/20 Ed. 2 Medical Elec. Equip.
	CHINA SJ/T 11364-2014, China RoHS Chart: http://en.globtek.com/globtek-rohs.php
	cRUus Registered E170507 CSA C22.2 No. 60950-1 2nd Ed.
	cRUus UL Recognized Component E172861 3rd Edition w-RM ANSI-AAMI ES60601-1 (2005 + C1:09 + A2:10) and CAN-CSA-C22.2 No. 60601-1 (2008)
	Certification # TC RU AR46.B.75423 Custom Union of Russia, Belarus and Kazakhstan
	FCC PART 15 CLASS B IEC/EN60335-1 IEC/EN60335-1 Up to 36 volts IEC/EN60601-1 IEC/EN60601-1

Delivering leading edge, innovative power solutions for more than 30 years....

Model:GTM91120-30VV-P2(SR with SAA Plug 2 pin)

August 18, 2019

IEC/EN60950-1	IEC/EN60950-1
	Indoor Use Only - Mark is on the label or Molded in the case
IP68	Ingress Protection: ?IP68 to IEC60529:2001 Totally dust tight and Protected against long periods of immersion under pressure
EFFICIENCY LEVEL	
Efficiency: complies to section 301 of Energy Independence and Security Act (EISA) complies with Energy Star tier 2 (North America), ECP tier 2 (China), MEPS tier 2 (Australia), Code of Conduct (Europe)	
LPS	Limited Power Source
	JAPAN TUV Rheinland-PSE GlobTek Inc to J60950-1(H26) , J55022(H22),J3000(H25).Please follow the procedure listed in the following link for proper import to Japan: http://en.globtek.com/importing-to-japan.php .
GlobTek, Inc.	
	
    Class NO for production	Serial Number Information
	SIQ IEC/EN 60335-1 (Safety of Household and Similar Electrical Appliances, Part 1: General Requirements) up to 36 volts
IEC/EN60335-1	
	SIQ Mark License Certificate EN 60950-1:2006 + Am 1:2010+ Am 11:2009 + Am 12:2011
IEC/EN60950-1	
	SIQ Mark License EN60601-1, 3rd edition
IEC/EN60601-1	
	Ukraine UKRSepr (Document: www.globtek.com/html/iso_certificates/GT_Ukraine.pdf)
10276	
	Japan: Voluntary Control Council for Interference (VCCI)
	WEEE: Complies with EU 2012/19/EU (http://ec.europa.eu/environment/waste/weee/index_en.htm) Mark is on the label or Molded in the case