

Delivering leading edge, innovative power solutions for more than 30 years....

Model:GT-86240-WVVV-X.X-D2

September 19, 2019

GT-86240-WVVV-X.X-D2

Information

Model Number GT-86240-WVVV-X.X-D2

Description GT-86240-WVVV-X.X-D2, ITE Power Supply, Open Frame/Internal, Regulated Switchmode AC-DC Power Supply AC Adaptor, , Input Rating: 100-240V~, 50-60Hz, Solder Pins for Line and Neutral, 1.14 mm square pins, 11.43 mm long, Output Rating: 24 Watts, Power rating with convection cooling (W) , 12VV in 0.1V increments, Approvals: CE; China RoHS; Double Insulation; EAC; PSE; Level VI; WEEE; VCCI; Ukraine; RoHS;

Model Picture

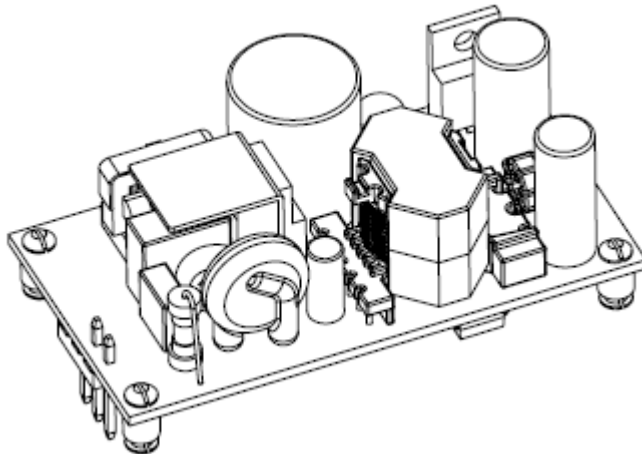

Agency Documents [http://www.globtek.info/certs/GT-86240\(-W2\)/](http://www.globtek.info/certs/GT-86240(-W2)/)
CE https://www.globtek.com/pdf/ec_declaration/a000c00000PldpOEAT
EC-Declaration https://www.globtek.com/pdf/rohs_cert/a000c00000PldpOEAT
RoHS/RoHS2 Declaration https://www.globtek.com/pdf/iso_certificates/REACH.pdf
REACH Declaration https://www.globtek.com/pdf/iso_certificates/REACH.pdf
Conflict Minerals Declaration <https://www.globtek.com/pdf/conflict-minerals.pdf>

Delivering leading edge, innovative power solutions for more than **30** years....

Model:GT-86240-WWVV-X.X-D2

September 19, 2019

Model Parameters

Type	Open Frame/Internal
Technology	Regulated Switchmode AC-DC Power Supply AC Adaptor
Category	ITE Power Supply
Input Voltage	100-240V~, 50-60Hz
I/P Amps (A)	1A
Wattage (W)	24.0
Vout Range (V)	12V
Efficiency Level	VI
Ingress Protection	IPX0
Size (mm)	76.2*40.30*29.4

Delivering leading edge, innovative power solutions for more than 30 years....

Model:GT-86240-WWVV-X.X-D2

September 19, 2019

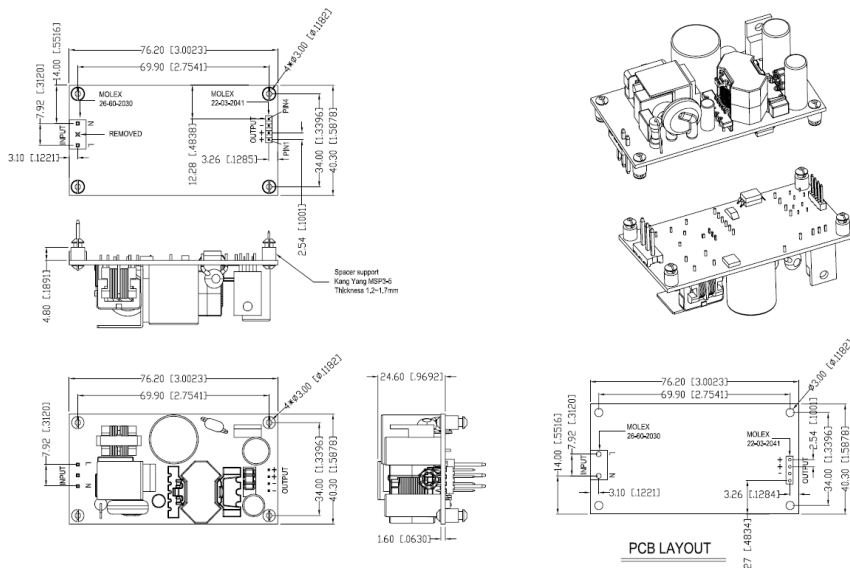
ENCLOSURE

Delivering leading edge, innovative power solutions for more than **30** years....

Model:GT-86240-WVVV-X.X-D2

September 19, 2019

RATING TABLE

Model Number	Voltage(V)	Amps(A)	Watts(W)	RFQ
GT-86240-2412-D212	24	1	24.00	RFQ

SPECIFICATIONS

A) ELECTRICAL SPECIFICATIONS:

01. Input Voltage: Specified 90-264 Vac, Nameplate rated: 100-240Vac
02. Input Frequency: Specified 47-63 Hz, Nameplate rated 50-60Hz
03. Output Regulation: +/- 5%
04. Ripple and Noise (Vp-p): 300 mVp-p maximum, At 20 MHz, and output parallel with 0.1uF & 47uF capacitors to ground. Temperature at 25 °C, and nominal input voltage
05. Efficiency: Compliant with Efficiency Level VI and CoC Tier 2 standards
07. No Load Standby Power: <0.075W @ 230Vac
08. Turn-ON Delay: 3 Seconds maximum at nominal input voltage
09. Rise Time: 100mS maximum at nominal input voltage

B) PROTECTION

01. Over-Voltage: 20VDC maximum
02. Over current protection: 4A maximum with auto-recovery function
03. Short Circuit: Short circuit protection is to be included in the construction of the adaptor. The adaptor is designed to withstand continuous current of a short circuit on the output. The adaptor will be short circuit tolerant for an indefinite period.

C) SAFETY

01. Dielectric Withstand Voltage: 4242Vdc from primary to secondary
02. Leakage current: 0.25mA maximum, at nominal AC input voltage and frequency
03. ESD: 8KV(air) / 4KV (contact)

D) OTHER:

01. MTBF: 200,000 Hours @ 25°C ambient temperature
02. Operating Temperature: 0°C to 40°C ambient temperature
03. Humidity: 0% to 90% relative humidity
04. Storage Temperature: -10°C to 80°C
05. Cooling: natural convection cooling
06. ROHS 2: Complies with EU 2011/65/EU and China SJ/T 11363-2006

E) ENCLOSURE

01. Housing: High impact plastic, 94V0 polycarbonate, non-vented
02. Markings: Label and/or Pad Printed and/or Molded in the case

Delivering leading edge, innovative power solutions for more than 30 years....

Model:GT-86240-WVVV-X.X-D2

September 19, 2019

DERATING CURVE

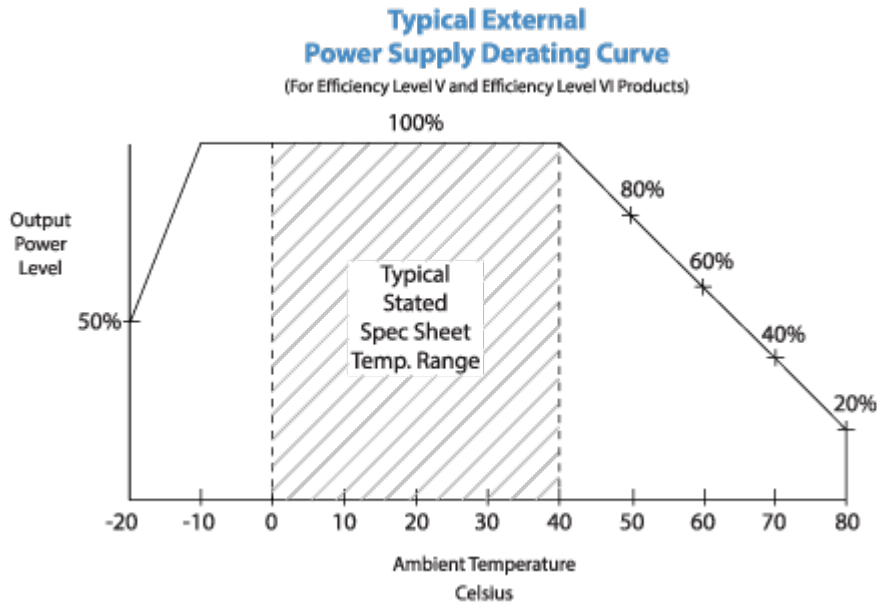

Delivering leading edge, innovative power solutions for more than **30** years....

Model:GT-86240-WVVV-X.X-D2

September 19, 2019

Input Configuration











Description Solder Pins for Line and Neutral, 1.14 mm square pins, 11.43 mm long

Delivering leading edge, innovative power solutions for more than **30** years....

Model:GT-86240-WVVV-X.X-D2

September 19, 2019

Approvals

Logo	Description
	Attention Mark / Refer to operating manual for operating and service instructions
	CE Mark: tested to comply with EN55022:2010 Class B, EN61000-3-2, EN61000-3-3 including EN61000-4-2, EN61000-4-3, EN61000-4-4, EN61000-4-5, EN61000-4-6N EN61000-4-11; EMI: Complies with EN55011 CLASS B and FCC Part 15B - On label or Molded in case
	CHINA SJ/T 11364-2014, China RoHS Chart: http://en.globtek.com/globtek-rohs.php
	Declaration ДС № EAЭC N RU Д-US.KA01.B.10453_19 Custom Union of Russia, Belarus and Kazakhstan http://www.globtek.com/redirect/?loc=gost-certificate-eac-declaration
	Indoor Use Only - Mark is on the label or Molded in the case
 GlobTek, Inc.	JAPAN TUV R-PSE, Cert. No. JD 50313285, to J60950-1(H26) , J55022(H22),J3000(H25)[15V or less]. Please reference the following website for guidelines on PSE regulations: http://en.globtek.com/importing-ite-and-medical-power-supplies-ac-adaptors-to-japan/
EFFICIENCY LEVEL VI 	Efficiency: complies to section 301 of Energy Independence and Security Act (EISA) complies with Energy Star tier 2 (North America), ECP tier 2 (China), MEPS tier 2 (Australia), Code of Conduct (Europe)
RoHS	Specifications of directive 2011/65/EU Annex VI (ROHS-2) with amendment 2015/863-EU (ROHS-3) http://www.ce-mark.com/Rohs%20final.pdf
 10276	Ukraine UKRSepr (Document: www.globtek.com/html/iso_certificates/GT_Ukraine.pdf)
	Japan: Voluntary Control Council for Interference (VCCI)
	WEEE: Complies with EU 2012/19/EU (http://ec.europa.eu/environment/waste/weee/index_en.htm) Mark is on the label or Molded in the case