

Delivering leading edge, innovative power solutions for more than **30** years....

Model:GTM86100-10VV-W2K-USB

September 19, 2019

## GTM86100-10VV-W2K-USB

### Information

Model Number GTM86100-10VV-W2K-USB

Description GTM86100-10VV-W2K-USB, ITE / Medical Power Supply, Wall Plug-in, AC/DC Switching Adaptor with USB Power Supply AC Adaptor, , Input Rating: 100-240V~, 50-60Hz, European CEE 7/16 configuration: Europlug 2 PIN, Output Rating: 10 Watts, Power rating with convection cooling (W) , 5-5.2V in 0.1V increments, Approvals: CB 60335; CE; China RoHS; Double Insulation; Level VI; VCCI; RoHS; WEEE; EAC; CB 62368;

Model Picture



Agency Documents <http://www.globtek.info/certs/GTM86100/>

CE Declaration [https://www.globtek.com/pdf/ec\\_declaration/a000c00000PH1ppEAD](https://www.globtek.com/pdf/ec_declaration/a000c00000PH1ppEAD)

RoHS/RoHS2 Declaration [https://www.globtek.com/pdf/rohs\\_cert/a000c00000PH1ppEAD](https://www.globtek.com/pdf/rohs_cert/a000c00000PH1ppEAD)

REACH Declaration [https://www.globtek.com/pdf/iso\\_certificates/REACH.pdf](https://www.globtek.com/pdf/iso_certificates/REACH.pdf)

Conflict Minerals Declaration <https://www.globtek.com/pdf/conflict-minerals.pdf>

Delivering leading edge, innovative power solutions for more than **30** years....

Model:GTM86100-10VV-W2K-USB

September 19, 2019

**Model Parameters**

Type	Wall Plug-in
Technology	AC/DC Switching Adapter with USB Power Supply AC Adaptor
Category	ITE / Medical Power Supply
Input Voltage	100-240V~, 50-60Hz
I/P Amps (A)	0.3A
Wattage (W)	10.0
Vout Range (V)	5-5.2
Efficiency Level	VI
Ingress Protection	
Size (mm)	69.6*24.0*39.0 +/-1

Delivering leading edge, innovative power solutions for more than 30 years....

Model:GTM86100-10VV-W2K-USB

September 19, 2019

ENCLOSURE

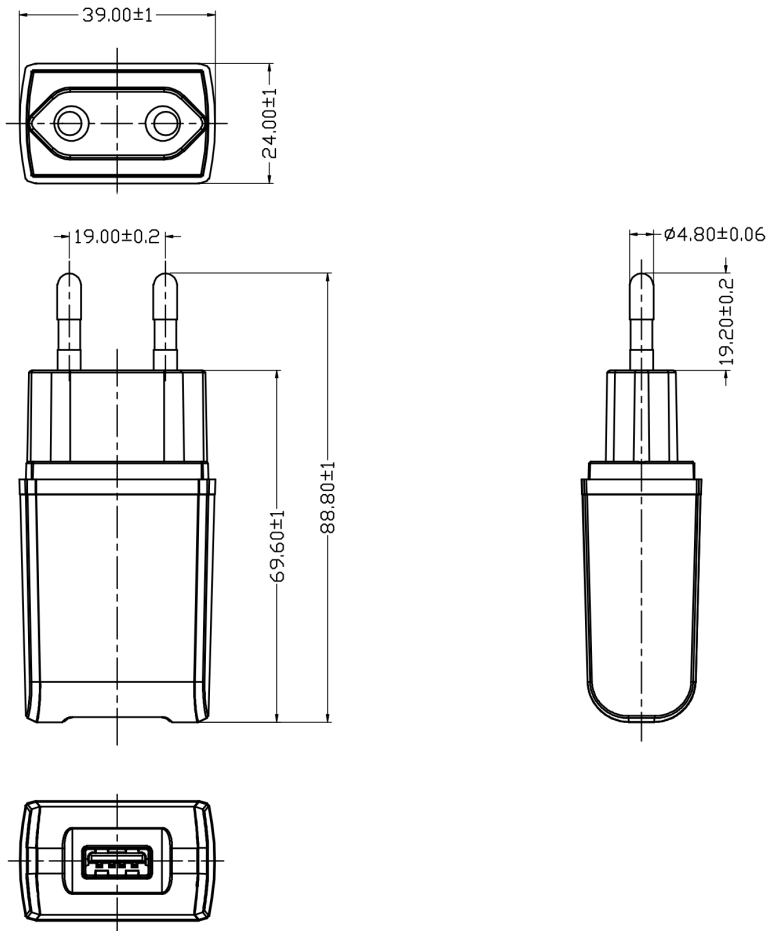

Delivering leading edge, innovative power solutions for more than **30** years....

Model:GTM86100-10VV-W2K-USB

September 19, 2019

**RATING TABLE**

Model Number	Voltage	Amps(A)	Watts(W)	RFQ
GTM86100-1005-W2K-USB	5 V	2	10.00	<a href="#">RFQ</a>

Delivering leading edge, innovative power solutions for more than 30 years....

Model:GTM86100-10VV-W2K-USB

September 19, 2019

**SPECIFICATIONS**

01. Input Voltage: Specified 90-264 Vac, Nameplate rated: 100-240Vac
02. Input Frequency: Specified 47-63 Hz, Nameplate rated 50/60Hz
03. Output Regulation: +/- 5% measured at the end of a 1 meter USB cordset employing #20 Gauge conductors
04. Line Voltage Regulation: +/- 1% typical measured at the end of a 1 meter USB cordset employing #20 Gauge conductors
05. Output Ripple (Vp-p): 100 mVpp max, measured at the end of a 1 meter USB cordset employing #20 Gauge conductors. Measured at 20 MHz bandwidth with 0.1 uf ceramic capacitor in parallel with a low impedance 47 uf electrolytic capacitor connected at the end of the output connector.
06. Hold-up Time: 5 mS minimum
07. Inrush Current: 30A maximum @ 230Vac input
08. Energy Efficiency: Complies to Efficiency Level VI and ErP European Commission's Ecodesign Directive (2005/32/EC) / CoC Tier 2 Compliant

**B) PROTECTION**

01. Over-current protection: 4A maximum with auto-recovery function
02. Over-voltage protection: 10VDC maximum with zener clamp
03. Short-circuit protection: The adapter shall not be damaged by short the DC output to Ground.

**C) SAFETY**

01. Dielectric Withstand Voltage: Primary To Secondary: 4000VAC or 5656VDC for 3 seconds
02. Leakage Current: 50uA maximum, at nominal 240Vac input voltage
03. ESD Immunity per EN61000-4-2, ±8 kV contact, ±15 kV air, Perf Criteria A Standard.

**D) EMC**

01. Emissions, per EN 55032, EN 61000-6-3, EN 61000-6-4
  - Conducted Emissions: Class B, FCC Part 15, Class B
  - Radiated Emissions: Class B, FCC Part 15, Class B
02. Line Frequency Harmonics EN61000-3-2, Class A
03. Voltage Fluctuations/Flicker EN61000-3-3
04. Immunity, per EN 55024, EN 61000-6-1, EN 61000-6-2
  - Static Discharge Immunity EN61000-4-2, 8kV Contact Discharge, 15kV air discharge
  - Radiated RF Immunity EN61000-4-3, 3V/m 80-2700MHz, 80% 1KHz AM.
  - EFT/Burst Immunity EN61000-4-4, 2kV/100kHz.
  - Line Surge Immunity EN61000-4-5, 1kV differential, 2kV common-mode
  - Conducted RF Immunity EN61000-4-6, 3Vrms, 80% 1KHz AM
  - Power Frequency Magnetic Field Immunity EN61000-4-8, NA
  - Voltage Dip Immunity EN61000-4-11, Criteria

**E) OTHER:**

01. MTBF: 300,000 Hours @ 25°C ambient temperature
02. Operating Temperature: 0°C to 50°C ambient temperature
03. Operating Humidity: 20 ~ 85 % RH. non-condensing
05. Storage Temperature: -20°C to 60°C
06. Storage Humidity: 5 ~ 95 % RH. non-condensing
07. Cooling: Natural convection cooling
08. RoHS 2: Complies with EU 2011/65/EU China SJ/T 11364-2014

**F) ENCLOSURE**

01. Housing: High impact plastic, 94V0 polycarbonate, non-vented
02. Markings: Label and/or Pad Printed and/or Molded in the case

**F) OPTIONS:****PROPRIETARY INFORMATION**

PROPRIETARY OF GLOBTEK, INC. ANY REPRODUCTION, DISCLOSURE OR USE OF THIS DRAWING, IN WHOLE OR IN PART, IS HEREBY PROHIBITED EXCEPT AS SPECIFIED IN WRITING BY GLOBTEK, INC.

<http://en.globtek.com/datasheet/id/a000c00000PH1pp>

Delivering leading edge, innovative power solutions for more than **30** years....

Model:GTM86100-10VV-W2K-USB

September 19, 2019

01. Green Power On Indicator LED
02. NEMA 1-15P or European Schuko 7-16 AC Plug Configuration
03. Increased DC Output Voltage (up to 5.4V) to allow for long output cables
04. Special International Safety Approvals
05. Housing Color, special markings

Delivering leading edge, innovative power solutions for more than 30 years....

Model:GTM86100-10VV-W2K-USB

September 19, 2019

DERATING CURVE

**Typical External  
Power Supply Derating Curve**

(For Efficiency Level V and Efficiency Level VI Products)

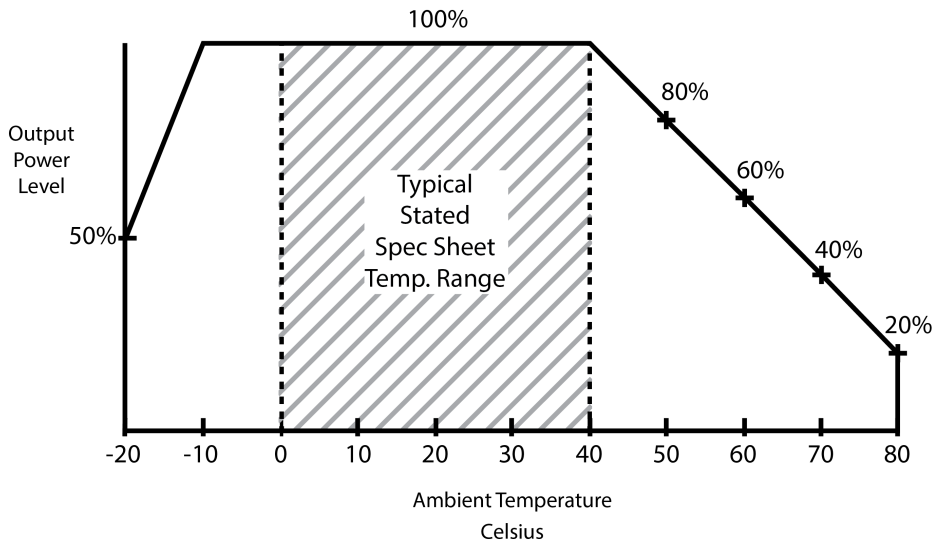

Delivering leading edge, innovative power solutions for more than 30 years....

Model:GTM86100-10VV-W2K-USB

September 19, 2019

## Input Configuration

Description European CEE 7/16 configuration: Europlug 2 PIN

The prongs of the Europlug are 19 mm long. They consist of a 9 mm long conductive tip of 4 mm diameter with a rounded ending, followed by a 10 mm long flexible insulated shaft of not more than 3.8 mm diameter. The two prongs are not exactly parallel and converge slightly; their centres are 19 mm apart at the tip and 18.6 mm apart at the base. The elasticity of the converging prongs provides sufficient contact force for the Europlug's current rating with a variety of socket-hole arrangements. The entire plug is 35.3 mm wide and 13.7 mm high, and must not exceed these dimensions within 18 mm behind its front plane (this allows for the recesses on many European socket types). The left and right side of the plug are formed by surfaces that are at 45° relative to the horizontal plan.

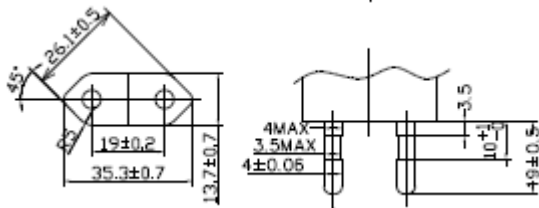



Delivering leading edge, innovative power solutions for more than 30 years....

Model:GTM86100-10VV-W2K-USB

September 19, 2019

**Output Configuration**

Common output connector options:

 L Type (Coaxial  
5.5x2.5mm plug)

 C Type (Coaxial  
5.5x2.1mm plug)

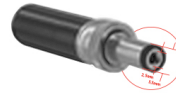
 K Type (Coaxial  
3.5x1.3mm plug)

 LL Type (5.5x2.5mm  
Locking 760k type)

 CL Type (5.5x2.1mm  
Locking S761k type)

 ML2 Type (Molex  
housing 43025-0200)

YL3 Type (KPPX-3P)



YL4 Type (KPPX-4P)

 EJ1/2/3/4/5 (EIAJ  
RC-5320A type  
connectors)

MSB Type (Micro USB)

 USBC Type (USB Type  
C)

 Inquire for custom  
design

 For a comprehensive list of options, [click here](#)







Contact GlobTek for your specific requirements or custom solutions.

Delivering leading edge, innovative power solutions for more than **30** years....

Model:GTM86100-10VV-W2K-USB

September 19, 2019

## Approvals

Logo	Description
No Logo Applicable	IEC 60335-1:2010+A1+A2
No Logo Applicable	CB for IEC 62368-1:2014 (Second Edition)
	CE Certification
	CHINA SJ/T 11364-2014, China RoHS Chart: <a href="http://en.globtek.com/globtek-rohs.php">http://en.globtek.com/globtek-rohs.php</a>
	Declaration ДС № EAЭC N RU Д-US.KA01.B.10453_19 Custom Union of Russia, Belarus and Kazakhstan <a href="http://www.globtek.com/redirect/?loc=gost-certificate-eac-declaration">http://www.globtek.com/redirect/?loc=gost-certificate-eac-declaration</a>
	Indoor Use Only - Mark is on the label or Molded in the case
<b>EFFICIENCY LEVEL</b> 	Efficiency: complies to section 301 of Energy Independence and Security Act (EISA) complies with Energy Star tier 2 (North America), ECP tier 2 (China), MEPS tier 2 (Australia), Code of Conduct (Europe)
RoHS	Specifications of directive 2011/65/EU Annex VI (ROHS-2) with amendment 2015/863-EU (ROHS-3) <a href="http://www.ce-mark.com/Rohs%20final.pdf">http://www.ce-mark.com/Rohs%20final.pdf</a>
	Japan: Voluntary Control Council for Interference (VCCI)
	WEEE: Complies with EU 2012/19/EU ( <a href="http://ec.europa.eu/environment/waste/weee/index_en.htm">http://ec.europa.eu/environment/waste/weee/index_en.htm</a> ) Mark is on the label or Molded in the case